

CET5 CANopen

CABLE EXTENSION TRANSDUCER

Absolute measuring length up to 5 m with integrated inclinometer



L.4 - DS0019 R00 CET5 CANopen



CHARACTERISTICS

Measuring range up to 5 m
Angle and length redundant sensors
Compact size
Linearity up to ± 0.5 % FS
High protection level and wide temperature range



ADVANTAGES

The measuring length suitable for every application
Designed for harsh environmental conditions
Reliability and long service life for outdoor applications
Firmware upgradable via proprietary bootloader
Hall effect technology



High protection level



Shock/vibration resistant

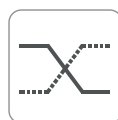

Redundant outputs

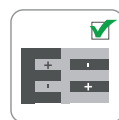

Reverse polarity protection

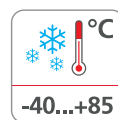

Wide temp. range

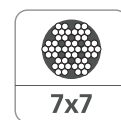

7x7 stainless steel rope



Ultra durable

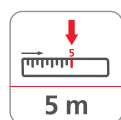

Max. length: 5 m



Dynamic Inclinometer



CANopen output



CANopen Safety

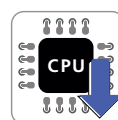

Firmware Upgradable



Directive 2011/65/EU



EU conformity

The company reserves the right to make any kind of design or functional modification at any moment without prior notice.

CET5 CANopen

CABLE EXTENSION TRANSDUCER

Absolute measuring length up to 5 m with integrated inclinometer



PRODUCT DESCRIPTION

CET5 is a robust, high-performance, wire cable pull transducer with CANopen output, designed for industrial applications and featuring high quality and durability.

Excellent repeatability, high IP rating, shock and vibration resistance and electromagnetic immunity makes this transducer suitable for mobile hydraulic applications such as: agricultural vehicles, earth moving machines, construction equipment, articulated arm cranes and aerial work platforms.



L.4 - DS0019 R00 CET5 CANopen



Agricultural machinery



Construction



Earth moving



Handling and lifting

CET5 CANopen

CABLE EXTENSION TRANSDUCER

Absolute measuring length up to 5 m with integrated inclinometer



PRODUCT CODE

ORDER CODE⁽¹⁾
▶

CET5.
a
b
c
d
e
f
g

a Measurement range
5000 ◀ = 5 m

b Power supply range
2 ◀ = 9 ... 30 V DC
6 ◀ = 8 ... 36 V DC

c Output type
6 ◀ = CANopen
43 ◀ = CANopen safety

d Connections
1 ◀ = Male flange connector M12, 5-pin
13 ◀ = Deutsch DT04-6P, PUR cable 70cm
20 ◀ = Deutsch DT04-4P, PUR cable 30cm
36 ◀ = Deutsch DT04-6P, PUR cable 70cm + 120 Ohm

e Architecture⁽²⁾
X ◀ = Redundant linear sensors
IR ◀ = Redundant linear & tilt sensors

f Customization
X ◀ = None
? ◀ = Customization code

g Approvals
1 ◀ = Standard components⁽³⁾
2 ◀ = SIL2/PLd

L.4 - DS0019 R00 CET5 CANopen

(1) Not all combinations can be ordered. Please contact TSM for confirmation before placing an order.
 (2) Redundant primary measures, acquired by a single logical unit and published on the CANOpen output by one or more PDOs, according to the selected mapping.
 (3) MTTFd > 100 years (EN ISO 13849-1) a) b)
 a) Standard component. It does not constitute a safety component as defined in the Machinery Directive 2006/42/CE.
 b) Every second failure of an electronic component is regarded as a dangerous failure.

CET5 CANopen

CABLE EXTENSION TRANSDUCER

Absolute measuring length up to 5 m with integrated inclinometer



TECHNICAL SPECIFICATION

Measuring range	5m (Linear); 0 ... 359.9° (Angle)
Wire material	AISI304 steel wire with nylon coating \varnothing 0.9 mm
Rope breaking force	typ. 330 N
Wire fastening	Eyelet Inner diameter \varnothing 8 mm Outer diameter \varnothing 15 mm Height 5 mm
Wire pull-out max speed	1 m/s
Cable transducer resolution	0.1 mm
Cable transducer linearity (Ta = 25°C)	± 0.5 % FS
Cable transducer repeatability (Ta = 25°C)	± 0.3 % FS
Inclinometer resolution	0.1 °
Inclinometer accuracy (Ta = 25°C)	± 0.3 °
Inclinometer temperature drift	± 0.01 °/°C typ.
Pull-in force	typ. 2 N (pull-in force reduced at low temperatures)
Pull-out force	typ. 8 N
Life cycles (Ta = 25°C)	500.000
Drum circumference	245 mm
Housing	Glass fiber reinforced polycarbonate
Protection class (Electronics compart.)	IP67 (acc. to EN 60529)
Temperature range	-40°C ... +85°C
Weight approx.	0.5 kg
Shock resistance	acc. to EN 60068-2-27 50 G, 11 ms, 100 shocks per axis Axis : X, Y, Z
Vibration resistance	acc. to EN 60068-2-6 10 ... 500 Hz, 10g, 2h per axis Axis : X, Y, Z



OPERATING PRINCIPLE

Construction

The core of a draw wire sensor is a bearings mounted drum on which a wire rope is wound. The unwinding of the rope drives the rotation of the drum, thus the linear displacement of the rope is converted into an angular displacement of the drum. By measuring the angle of the drum, the linear displacement of the wire is detected.

Caution

Exceeding the maximum extension length of the draw wire will lead to damage to the wire and the mechanics.

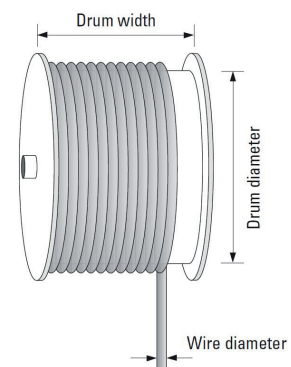

ELECTRICAL CHARACTERISTICS

Power supply range	See order code
Consumption typ.	42 mA (12 VDC, w/o load) 21 mA (24 VDC, w/o load)
Startup time	< 1.5 s
Interface	CANopen CANopen Safety
CANopen profile conformity	CiA DS301
Electromagnetic compatibility	acc. to EN 61326-1, EN 61326-3-1
EU Conformity	EMC directive 2014/30/EU RoHS directive 2011/65/EU + 2015/863/EU

CET5 CANopen

CABLE EXTENSION TRANSDUCER

Absolute measuring length up to 5 m with integrated inclinometer



ELECTRICAL CONNECTION M12 X 5 PINS

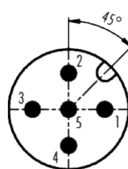

Pinout

1	CAN-GND*
2	+Vin
3	GND*
4	CAN-H
5	CAN-L

* GND and CAN_GND terminals are internally connected to each other and identical in their function

ELECTRICAL CONNECTION DEUTSCH DT04-6P



Pinout

1	+Vin
2	GND
3	CAN H
4	CAN L
5	n.c.**
6	n.c.**

** PIN MARKED n.c. MUST NOT BE CONNECTED

ELECTRICAL CONNECTION DEUTSCH DT04-4P

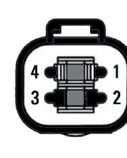

Pinout

1	+Vin
2	GND
3	CAN H
4	CAN L



ANGLE SENSOR

CET5 can be ordered with the optional integrated angle sensor.

The single axis tilt sensor allows to detect the angular change around the axis perpendicular to the installation plane. Several user settings are available, such as:

- Output range selection $\pm 180^\circ$ and $0 \dots 360^\circ$
- Direction of rotation (CW/CCW)
- Zero point setting (Preset/Offset)
- Output filter bandwidth

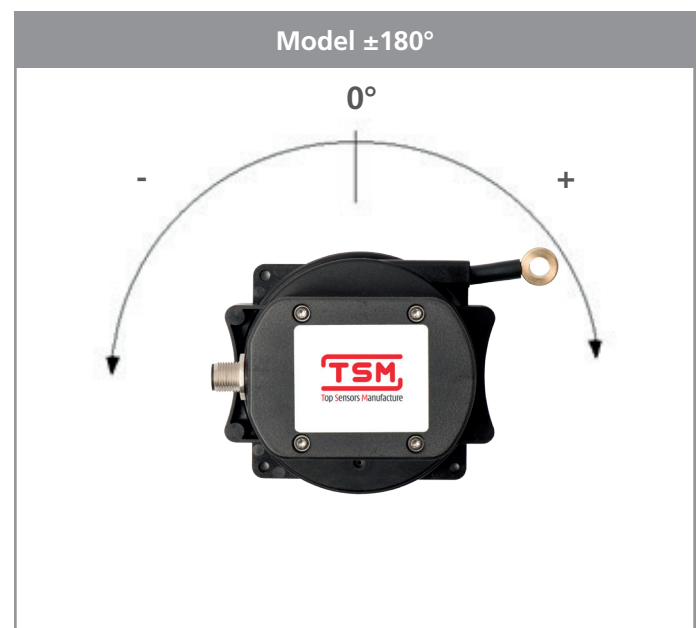
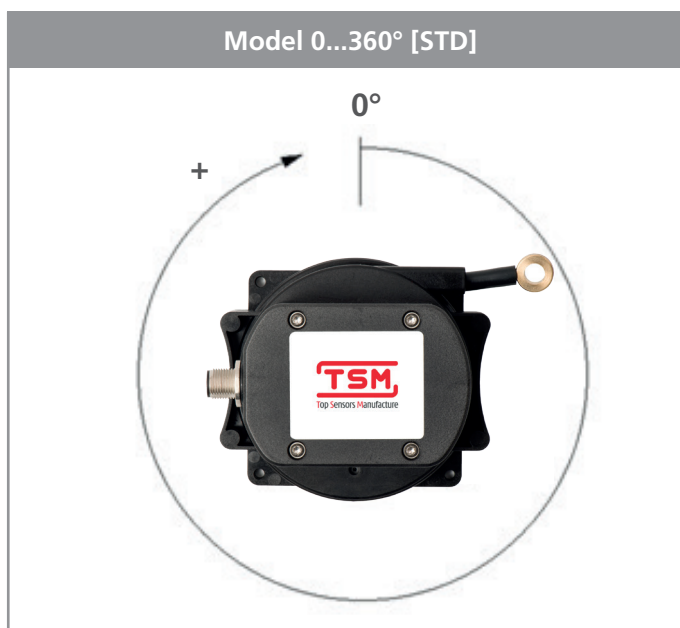

CET5 CANopen

CABLE EXTENSION TRANSDUCER

Absolute measuring length up to 5 m with integrated inclinometer



DIMENSIONS [mm]

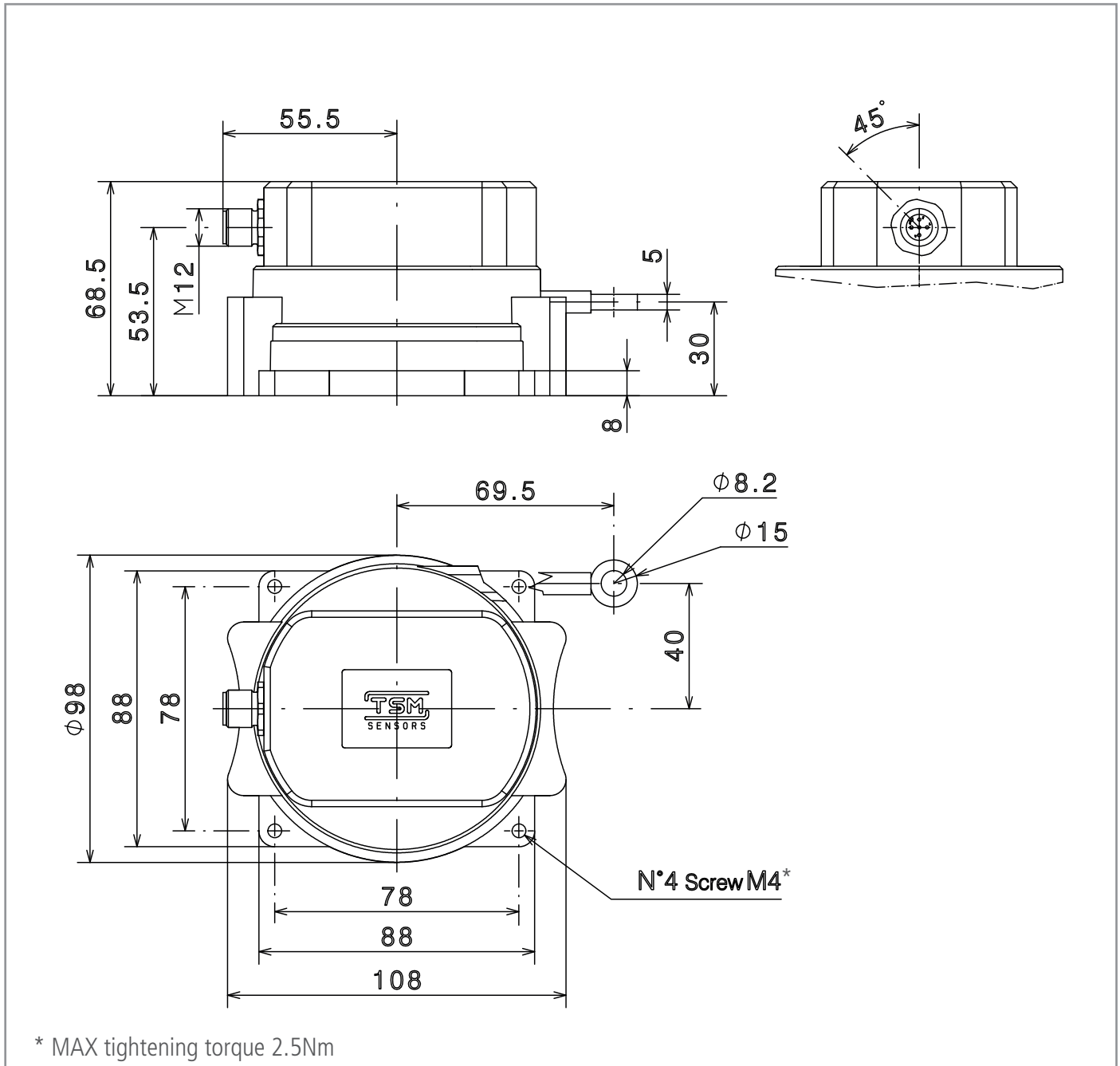

L.4 - DS0019 R00 CET5 CANopen