

USER MANUAL

QG65N2 CANopen Inclinator (Type I)

V2.1, Mar-22



DIS Sensors bv

Oostergracht 40

3763 LZ Soest | The Netherlands

T +31 (0)35 - 603 81 81

M info@dis-sensors.com

W www.dis-sensors.com

Contents

1.	Safety information	3
1.1.	Intended use.....	3
1.2.	Incorrect use.....	3
1.3.	Sensor defective	3
2.	About this manual	4
2.1.	Intended use.....	4
2.2.	Symbols used in the text	4
2.3.	Copyright	4
2.4.	Document revision control.....	5
3.	Quick reference.....	6
4.	Installation guide.....	7
4.1.	Mechanical drawing	7
4.2.	Mounting.....	7
4.3.	Connection	8
4.4.	CAN termination.....	9
5.	Technical data	9
6.	Functional description.....	10
6.1.	Inclination measurement principle	10
6.2.	Measuring axis and direction	10
6.2.1.	Measuring axis and direction for Inclination	10
6.2.2.	Measuring axis and direction for acceleration	11
6.3.	Signal processing	12
6.3.1.	Sampling rate.....	12
6.3.2.	Filter algorithm	12
6.3.3.	Digital filters.....	12
6.4.	Function mode	14
6.5.	Output format	15
6.6.	Boot-up procedure	16
6.7.	Emergency message	16
6.8.	LSS (Layer Setting Service, according to CiA305-DSP)	17
6.9.	Firmware management	17
6.10.	Load factory default settings.....	19
6.11.	Zero adjustment	20
6.12.	EDS & DCF.....	20
6.13.	Mappable objects.....	21
7.	CANopen specification	22
7.1.	CANopen Communication Objects (COB).....	22
7.2.	Predefined CAN-IDs.....	22
7.3.	PDO (Reading sensor output).....	23
7.4.	SDO (configuring Object Dictionary)	23
7.5.	NMT state.....	23
7.6.	Object Dictionary (device parameters)	24
8.	CAN Object dictionary overview	25
8.1.	Communication profile (Index 1000h - 1FFFh)	25
8.1.1.	Object 1001 _h Error register.....	27
8.1.2.	Object 1002 _h Manufacturer status register	27
8.1.3.	Object 1003 _h Predefined error field	28
8.1.4.	Object 1005 _h COB-ID SYNC message.....	29
8.1.5.	Object 1006 _h Communication cycle period	29
8.1.6.	Object 1010 _h Store parameters	29
8.1.7.	Object 1011 _h Restore factory default parameters.....	30
8.1.8.	Object 1014 _h COB-ID EMCY	30

- 8.1.9. Object 1020_h verify configuration..... 30
- 8.1.10. Object 1029_h error behaviour 30
- 8.1.11. Object 1800_h, 1801_h TPDO communication parameter 31
- 8.1.12. Object 1A00_h, 1A01_h TPDO Mapping parameter 31
- 8.1.13. Object 1F80_h NMT start-up behaviour..... 32
- 8.2. Manufacturer-specific profile (2000_h - 5FFF_h)..... 33
 - 8.2.1. Object 3007_h Function mode 34
 - 8.2.2. Object 300F_h Zero adjustment Inclination 34
 - 8.2.3. Object 301E_h Manufacturer status register error mask..... 34
 - 8.2.4. Object 301F_h Manufacturer status register mapping 35
 - 8.2.5. Object 300E_h Output filter 35
 - 8.2.6. Object 300D_h Moving average filter TPDO1 and TPDO2 35
 - 8.2.7. Object 3014_h Lowpass filter 36
 - 8.2.8. Object 3032_h Sub Range Limits..... 36
- 8.3. Standardized device profile (6000_h – 9FFF_h) (CiA410) 37
 - 8.3.1. Object 6000_h Resolution 38
 - 8.3.2. Object 6011_h, 6021_h Operating parameter 38
 - 8.3.3. Object 6012_h, 6022_h Pre-set inclination value..... 38
 - 8.3.4. Object 6013_h, 6023_h Offset inclination value..... 38
 - 8.3.5. Object 6401_h Sensor outputs..... 39
- 8.4. Data type 39
- 9. Configuration tool 40
 - 9.1. Configuration kit..... 40
 - 9.2. PC software 41
- 10. Abbreviations and definitions 47
- 11. Normative references 47

1. Safety information

1.1. Intended use

The QG65N2 CANopen Inclinometer is a MEMS-based inclination sensor with **CANopen** interface. This device provides precise and reliable inclination measurement in (semi)static conditions. The use of this device in a machine or system is permitted only under the following conditions:

- The user is trained and competent in the integration and use of inclination sensors in machinery.
- The user is familiar with the contents of both the datasheet and user manual.
- The user has a full understanding of CAN and CANopen.
- The device is used within the specified environmental conditions.
- The device is properly configured for its intended use.
- The device is mounted correctly as described in the datasheet and user manual.
- The device data is expressly not interpreted as safety data, except when used redundantly in a control system that is designed and tested for cross-check functionality between the primary and redundant devices.

1.2. Incorrect use

- Use of non-standard CAN cables.
- Device mounted incorrectly.
- Zero adjustment outside the specified range.
- Incorrect or absent CAN bus termination.
- Device used outside the specifications.

1.3. Sensor defective

The sensor is considered “defective” when

- No CAN output can be detected.
- An emergency message with sensor error information is detected. (→ 6.7 Emergency message)

In the event of uncertainty, contact the distributor or manufacturer. Any unauthorised modification or unapproved use will void both the warranty and any liability on the part of the manufacturer.

2. About this manual



2.1. Intended use

This manual applies solely to the QG65N2 CANopen inclinometer (Type I) with the following model designations:

- QG65N2-KIXv-360-CAN-C(F)M-UL — 1 axis, $\pm 180^\circ$, vertical mounting, std. accuracy.
- QG65N2-KDXYh-090-CAN-C(F)M-UL — 2 axes, $\pm 90^\circ$, horizontal mounting, std. accuracy.
- QG65N2-KDXYh-030-CAN-C(F)M-UL — 2 axes, $\pm 30^\circ$, horizontal mounting, std. accuracy.
- QG65N2-KIXv-360H-CAN-C(F)M-UL — 1 axis, $\pm 180^\circ$, vertical mounting, high accuracy.
- QG65N2-KDXYh-090H-CAN-C(F)M-UL — 2 axes, $\pm 90^\circ$, horizontal mounting, high accuracy.
- QG65N2-KDXYh-030H-CAN-C(F)M-UL — 2 axes, $\pm 30^\circ$, horizontal mounting, high accuracy.

DIS product code can be identified [here](#).

2.2. Symbols used in the text

- | | |
|---|--|
| h | Subscript for hexadecimal values. |
| d | Subscript for decimal values. |
|  | Caution that indicates either potential damage to the sensor or explains how to avoid a problem. |
|  | Important information. |
| → | Cross-reference |

2.3. Copyright

© Copyright 2022 DIS Sensors bv.

This manual is subject to change without notice.

All rights according to the copyright remain explicitly reserved for DIS Sensors bv.

2.4. Document revision control

Version	Date(y-m-d)	Revision
V1.0	2021-03-19	1 st release.
V2.0	2021-07-02	<p>Correct errors in function mode 2, 6 and 7.</p> <p>Updated screenshots of configurator.</p> <p>Added message structure of object 1003h.</p> <p>Document revision control is put to the end of chapter2 due to the page length.</p> <p>Correct format 1003_h in table communication profile.</p> <p>Improved description of data processing.</p> <p>Correct command SYNC.</p> <p>Added high accuracy model name.</p>
V2.1	2022-03-18	<p>Configurator power adaptor needed when more than 1 sensor connected.</p> <p>Resolution configurable.</p> <p>Subrange configurable for 1-axis model.</p> <p>PC Application display resolution reduced to 1360x768p.</p> <p>Improved description boot-up procedure.</p>

Table 1 - Document revision

3. Quick reference

General

- 1-axis $\pm 180^\circ$ and 2-axes $\pm 30^\circ/\pm 90^\circ$ inclinometer
- Output type: CANopen
- Inclination, acceleration outputs defined by Function modes (\rightarrow [object 3007_h](#))
- Sensor outputs can be customised using TPDO mapping parameters (\rightarrow [object 1A00_h](#))
- Internal sample rate MEMS: 1000Hz; output rate: 100 Hz
- 2nd order Low pass Bessel filter: 10Hz (\rightarrow [object 3014_h](#))
- Output filter: adjustable 1st order LPF (\rightarrow [object 300E_h](#))
- Moving average filter: averaging time interval adjustable from 10 ms to 100 ms (\rightarrow [object 300D_h](#))
- An optional configurator is available (\rightarrow [DIS website](#))
- Approved for automotive use, approval number: E4-10R-05-4662

CAN, CANopen

- CAN interface: CAN2.0 A/B (compliant with ISO11898-1&2)
- CANopen application layer and communication profile: EN50325-4 (CiA301 v4.0 and 4.2.0)
- CANopen device profile for inclinometer: CiA410
- LSS (Layer Setting Service) implemented
- TPDO1 (CAN-ID: 180_h + Node ID) and TPDO2 (CAN-ID: 280_h + Node ID)
- Outputs: inclination X-axis (longitudinal) in object 6010_h; inclination Y-axis (lateral) in object 6020_h
- Internal switchable CAN termination resistor: default off (\rightarrow [object 3003_h](#))
- CAN bus bit rate: default 250 kbit/s (\rightarrow [object 3001_h](#))
- Node ID: default 01_h (\rightarrow [object 3000_h](#) range: 01_h – 7F_h, max. 127 nodes)
- Heartbeat: default on, 2 s (\rightarrow [object 1017_h](#))
- Two modes of PDO transmission (\rightarrow [object 1800_h](#)/[1801_h](#))
 - Event mode: default on, event timer default 100 ms (range 10 ms – 500 ms)
 - Sync mode: default off
- Vendor ID: 000001BD_h DIS Sensors (\rightarrow [object 1018_h](#))
- Firmware version available via CAN Object Dictionary (\rightarrow [object 1018_h](#))
- Serial number format: xxxxxx-xxx (\rightarrow [object 1018_h](#))
- Zero adjustment of inclination available via CAN Object Dictionary (\rightarrow [object 300F_h](#)).
- Pre-set inclination setting available via CAN Object Dictionary (\rightarrow [objects 6012_h](#) and [6022_h](#)).
- Bootup in NMT Operational state (\rightarrow [object 1F80_h](#))
- Negative values: two's complement
- Byte-sequence on CAN bus: little-endian (least significant byte first)

4. Installation guide

4.1. Mechanical drawing

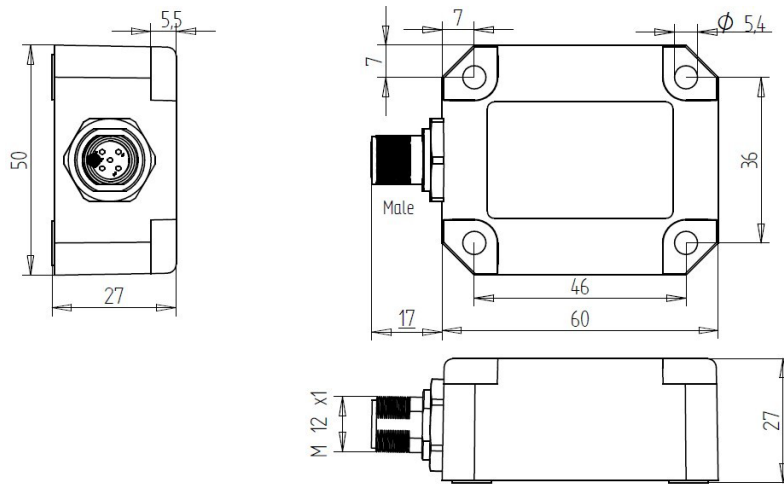

Figure 1 - Mechanical drawing of QG65N2 with a male M12.

4.2. Mounting

- Use the 4 screws provided (M5x25 mm zinc plated steel Pozidrive pan head screws with self-tapping PZ DIN7500CZ) to mount the device.
- If a software zero adjustment is impossible or undesirable, DIS provides an optional reference solution of replacing 2 of the provided screws with 2 optional 4mm \varnothing positioning pins, which can serve as mechanical reference.
- Tightening torque max. 2.5 Nm. A higher torque can cause damage to the housing or the internal electronics.
- Fix the sensor to a perfectly flat surface.
- A 1-axis inclinometer must be mounted vertically. The factory default zero position is with the male connector pointing down as shown in Figure 2 . Sensor can be zero adjusted at any position within the full range.
- A 2-axis inclinometer must be mounted horizontally. The factory default zero position is shown in Figure 2. After installation, sensor can be zero adjusted to eliminate the mechanical offsets within a $\pm 5^\circ$ offset range.



Figure 3 - Vertical mounting 1-axis inclination

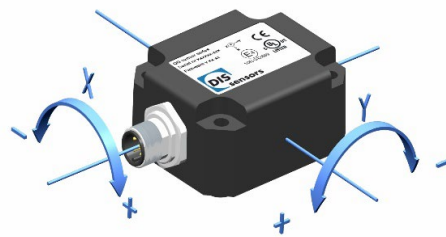

Figure 2 - Horizontal mounting 2-axes inclination

4.3. Connection

The sensor is equipped with either a single 5-pole M12 (A-coded) male connector according to IEC 61076-2-101, or with an additional 5-pole M12 (A-coded) female connector. This is specified in the suffix of the device model designation: suffix CM indicates single male connector; suffix CFM indicates both a female and a male connector.

The advantage of two connectors is that devices can be daisy-chained in the CAN network. The voltage supply is forwarded from the male to the female connector, providing both power and bus-connection to the next sensor with a single cable harness. The connection between male and female connector acts as an internal T-junction.

The pin assignment is according to CiA 303-1 V1.8.0.

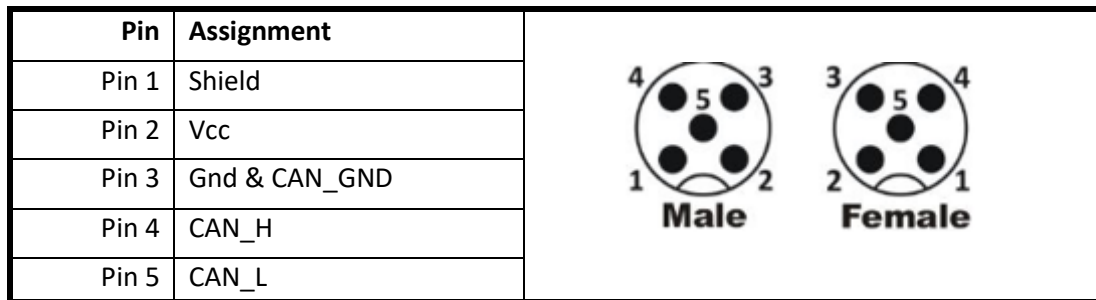

Figure 4 - Pin definition



- The maximum current for the internal T-junction is 2.5 A. This must be taken into account when using daisy-chained connections.
- The voltage supply must be dimensioned to prevent exceeding the specified voltage limits.
- The power consumption is about 50mA typical.
- This device must be connected to a class 2 power supply.
- Connect the sensor only to an approved CAN controller which must have a grounded shield. Alternative: connect the sensor housing to a grounded shield. All mentioned EMC standards that are met (see Declaration of Conformity) have been done with the housing connected to a grounded shield.



Installation of wiring and the opening and closing of electrical connections must only be carried out in de-energized state! Short-circuits, voltage spikes, etc. can cause malfunctions and/or cause the installation to become uncontrolled, creating a serious risk of injury or damage to property.

4.4. CAN termination

A CAN bus should be terminated properly to prevent signal reflections. The QG65N2 CANopen Inclinometer has an internal 120 Ohm termination resistor. By default, this is disabled, but it can be enabled with [object 3003h](#).

A separate M12 termination resistor and T-connector are also available as accessories for CANopen devices.



Figure 5 - M12 CAN terminator male 5p.
Order code: 10217



Figure 6 - M12 CAN terminator female 5p.
Order code: 10194



Figure 7 - M12 T-connector 5p.
Order code: 11822

The advantage of using a separate termination plug instead of the internal termination resistor is that an external termination plug is clearly visible. This helps to prevent an inadvertent double termination that could cause the entire CAN bus to malfunction.

5. Technical data

Please refer to the datasheet of your product.

6. Functional description

6.1. Inclination measurement principle

QG65N2 Inclinometers measure inclination by measuring static acceleration of gravity using an accelerometer MEMS. In static conditions, inclination measurement by this principle is accurate and reliable.

However, the vibrations or movements present on almost all industrial machines generate undesirable g-forces. These dynamic g-forces accumulate and overlay the static g-forces, causing a 'dirty' inclination output that includes spurious or noise components.

A low-pass filter can stabilize the output, that can be enough for some applications. The downside of this filtering is that it increases the reaction time (latency) of the inclinometer. In a control system this results in a limit on the speed of movements, and reduced machine efficiency.

If the dynamic effects are dominant and acceptable delay time is limited, please consider our Dynamic inclinometer, where with the help of a gyroscope a sort of filtering is achieved without having the downside of delay time.

6.2. Measuring axis and direction

6.2.1. Measuring axis and direction for Inclination

A single-axis inclinometer (vertical mount) measures the inclination in the vertical plane over the full range 0-360° (X-output). The default 0° position and the measuring direction are shown in Figure 8.



Figure 8 - Measuring axis and direction of 1-axis inclination.

A dual-axis inclinometer (horizontal mount) measures the inclination on both X and Y axis. Measuring range is up to 90°. Due to the measurement principle, only one axis may tilt more than 45°.

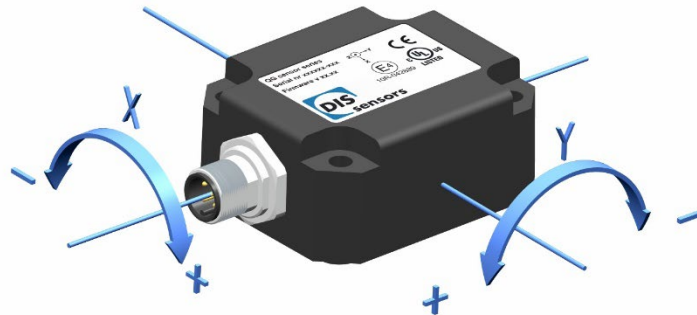



Figure 9 – Measuring axis and direction of 2-axis inclination.

 **Cross-tilt error:** when the cross axis (axis perpendicular to the measuring axis) tilts more than 45° during the measurement, the measuring axis will be disabled. The sensor will send a fixed CAN output to indicate that the sensor is now at a cross-tilt error position (→[Knowledgebase](#)): 20000_d (200°) for the measuring range ±180°, ±30°/±90°, and 40000_d (400°) for the measuring range 0°-360°. In addition, an EMCY message will also be sent, in which the last 5 bytes (00 00 00 00 01/02_h) specifies the cross-tilt error on the X or Y axis (→Object 1002h Manufacturer status register).

6.2.2. Measuring axis and direction for acceleration

In acceleration mode (→6.4 Function mode), the device measures the acceleration values on all 3 axes. The measuring direction of three axes in the factory default setting is shown in Figure 11.

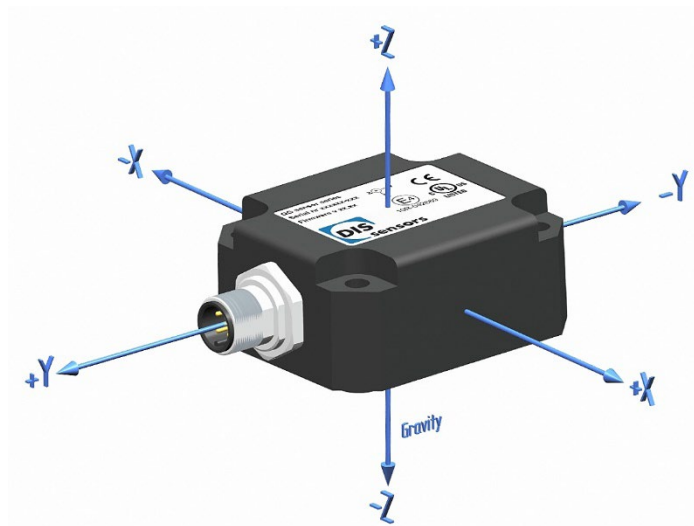

Figure 10 – Measuring axis and direction of acceleration.

6.3. Signal processing

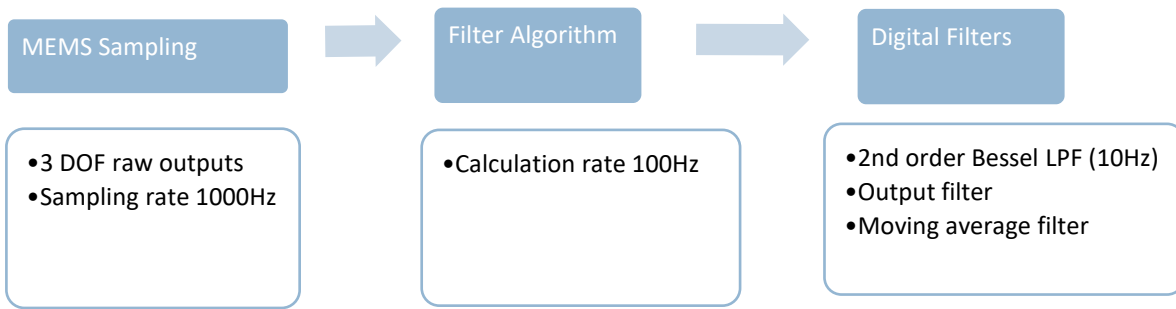

Figure 11 - Signal processing

6.3.1. Sampling rate

Each axis of the acceleration MEMS is sampled by the internal microcontroller at a rate of 1000 Hz. Those samples are fed into the filter algorithm and will be processed further.

6.3.2. Filter algorithm

Filter algorithm is implemented to improve the quality of the sampled raw data. The calculation rate is 100Hz.

6.3.3. Digital filters

The inclination values can be further processed with digital filters, which can significantly eliminate noises or reduce the bandwidth, making the sensor much less sensitive to accelerations or vibrations. Different filters can be enabled/disabled or configured with the DIS configurator set CAN, or with the CAN object dictionary.

Bessel Low pass filter

Normally, an inclinometer with a bandwidth of 10Hz is fast enough for most applications. Therefore a 2nd order low-pass Bessel filter with a fixed cut-off frequency of 10Hz is implemented. You can only turn this filter ON/OFF with [object 3014_h](#). This filter is ON as default and effective on all sensing axes. For standard inclination measurements it is highly recommended to leave this filter on.

Output filter

An additional 1st order low-pass filter called ‘**output filter**’ is implemented for further additional reduction of bandwidth and extra noise filtering. This filter is useful for slow-moving applications with a lower bandwidth than 10Hz. By setting a time-constant τ^1 in [object 300E_h](#), the cut-off frequency can be calculated by the formula $f = 1 / (2\pi * \tau)$. A longer filter time results in a narrower bandwidth and therefore less noise, but also causes a longer phase delay.

¹ τ time in which the output changes to 70% of the step after a step response

Normally this filter is used in addition to the 2nd order Bessel LPF. Therefore, it does not make sense to set the output filter to a higher frequency than 10Hz (i.e. τ should be $>16\text{ms}$). Common filter time are 50ms (3Hz), 100ms (1.6Hz) or 200ms (0.8Hz).

 This -3 dB frequency is independent of TPDO event time. However, when the output filter time-constant is set to a value lower than the TPDO event time, the output filter is automatically disabled. For example, if TPDO event time is set to 100 ms, and output filter time is set to 50 ms, this filter will not work.

Moving average filter

The final inclination output is an average of the last N samples. This filter can be used to reduce the noise level further, although it has only limited effect.

The sampling rate of this filter is 10 ms. This filter can be controlled via CAN object 300D_h.

 N must be a number from 0_d-10_d. Setting the N to 0_d and 1_d will disable this filter.

The TPDO event timer decides the cycle time of the TPDO message. By default, the sensor sends a new TPDO every 100 ms. This TPDO message contains an inclination measurement which is an average of the preceding N x 10ms samples and is totally independent of the TPDO event time.

Example:

TPDO event timer = 50 ms, N = 7: every 50 ms, a new average inclination value from the previous 70 ms samples will be supplied in the TPDO message.

6.4. Function mode

The QG65N2 can measure inclination and acceleration. By selecting the function mode via [object 3007_h](#), the sensor is configured to function as an inclinometer or accelerometer. Once a function mode is selected, the TPDO mapping parameters (→8.1.12, page 31) are automatically configured with the predefined objects and object entries. The user can also define the TPDO mapping objects manually; the function mode is then changed to Mode FF_h (user defined mode).

Function mode	Output	TPDO mapping objects (1A00 _h , 1A01 _h)
Mode 0 (default)	Inclination (CiA410)	TPDO1: 6010 _h - 00 _h (1-axis model) TPDO1: 6010 _h - 00 _h , 6020 _h - 00 _h (2-axis model) TPDO2: disabled
Mode 1	Inclination (CiA410) alternative orientation	TPDO1: 6010 _h - 00 _h (1-axis model inverted) TPDO1: 6020 _h - 00 _h , 6010 _h - 00 _h (2-axis model with X and Y swapped, X and Y inverted) TPDO2: disabled
Mode 2	Inclination (CiA410) + Temperature	TPDO1: 6511 _h -00 _h , 6010 _h - 00 _h (1-axis model) TPDO1: 6511 _h -00 _h , 6010 _h - 00 _h , 6020 _h - 00 _h (2-axis model) TPDO2: disabled
Mode 3	Acceleration (3 axes)	TPDO1: 6401 _h -01 _h , 6401 _h -02 _h , 6401 _h -03 _h TPDO2: disabled
Mode 4-5	Reserved	
Mode 6	Inclination (compatible with QG65 CAN firmware v4B)	TPDO1: 6401 _h - 0E _h , (1-axis model) 6401 _h - 04 _h , 6401 _h - 05 _h (2-axis model) TPDO2: disabled, 6401 _h - 01 _h , 6401 _h - 02 _h , 6401 _h - 03 _h
Mode 7	Inclination (compatible with QG65N CAN firmware v6)	TPDO1: 6401 _h - 04 _h (1-axis model) 6401 _h - 04 _h , 6401 _h - 05 _h (2-axis model) TPDO2: disabled, 6401 _h - 01 _h , 6401 _h - 02 _h , 6401 _h - 03 _h
Mode FF	User defined mode (Output defined by user)	TPDO1: user defined TPDO2: user defined

Table 2 – Sensor output configuration in different function modes.

6.5. Output format

Inclination output format with factory default resolution: CAN output = $100 \cdot \alpha$. (α = angle in degrees, factory resolution is 0.01°). The resolution can be configured with object 6000_h. CAN outputs are sent with PDOs (→7.3 PDO (Reading sensor output)).

For example:

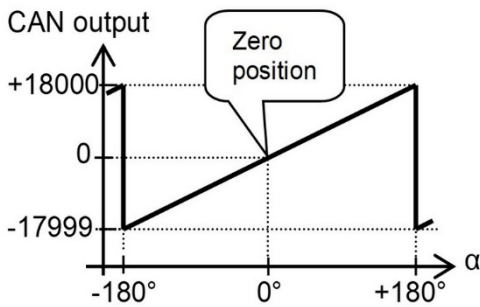

Figure 12 - Output 1-axis $\pm 180^\circ$ sensor

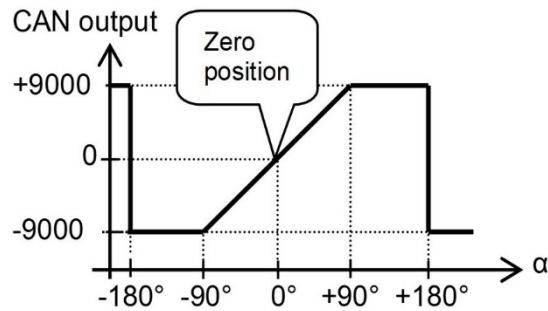

Figure 13 - Output 2-axis $\pm 90^\circ$ sensor

In Figure 12, the sensor sends 1 axis inclination output with 2 Bytes Integer (Table 3).

Byte1	Byte0
23 _h	82 _h
Inclination output: 2382 _h = 9090 _d = 90.9°	

Table 3 - Output 1-axis $\pm 180^\circ$ sensor

In Figure 13, the sensor sends 2 axis inclination outputs with 4 bytes integer. The 1st two bytes are the X inclination and the 2nd two bytes are the Y inclination (Table 4).

Byte3	Byte2	Byte1	Byte0
Y inclination		X inclination	
00 _h	82 _h	0B _h	C8 _h
0080 _h = 130 _d = 1.3°		0BC8 _h = 3016 _d = 30.16°	

Table 4 - TPDO1 of QG65N2-KDXYh-090H-CAN-C(F)M

Besides inclination values, the device also provides acceleration, angular rate and device temperature. The user can customise the device outputs by changing the TPDO mapping parameters. (→Object 1A00_h, 1A01_h TPDO Mapping parameter). For example, 1st two bytes are the device temperature, the 2nd two bytes are the inclination output (Table 5).

Byte3	Byte2	Byte1	Byte0
23 _h	82 _h	00 _h	1A _h
Inclination output: 2382 _h = 9090 _d = 90.9°		Device temperature: 001A _h = 26 _d °C	

Table 5 - Customised TPDO message

6.6. Boot-up procedure

When the device is powered on, it automatically enters NMT Initialisation state. In this state, the device will be initialised with the last stored parameters of the manufacturer-specific profile area and of the standardized device profile area. When initialisation is complete, a bootup message 00_h will be sent with the heartbeat (700_h + Node ID). If an error is detected during the bootup, an emergency message with the error information will be sent.

After that, the sensor will switch to either “Operational” (default) or “Pre-operational” mode, depending on the value of object 1F80_h.

6.7. Emergency message

When the device detects an internal error, an emergency object (80_h+Node ID) with 8-bytes message is transmitted. The error code is inserted at the location of [object 1003h \(pre-defined error field\)](#), and the device enters the error state which is defined in Object 1029_h Error Behaviour (default: NMT pre-operational state).

The first 3 bytes indicates the error code specified in CiA301 and error register specified in [Object 1001_h](#). The remaining 5 bytes indicate the manufacturer-specific error specified in [Object 1002_h](#).

Byte7	Byte6	Byte5	Byte4	Byte3	Byte2	Byte1	Byte0
Manufacturer-specific error (1002_h)					Error register (1001_h)		EMCY error code (CiA301)
00 00 00 00 00 _h = no error					00 _h = no error		00 00 _h = No error. Always sent at start-up
00 00 00 00 01 _h = X-axis Cross-Tilt Error					01 _h = Generic error		10 xx _h = Generic error
00 00 00 00 02 _h = Y axis Cross-Tilt Error					05 _h = Voltage error		50 00 _h = Voltage error
00 00 00 00 08 _h = EEPROM error					81 _h = Manufacturer specific error		50 10 _h = Self-test error
More:					More:		50 30 _h = Error during sensor initialization
→ 8.1.2 Object 1002h Manufacturer status register					→ 8.1.1 Object 1001h Error register		60 00 _h = Watchdog error
							60 00 _h = Error handler activated
							62 00 _h = Device software error
							80 00 _h = Sent at every change of the manufacturer status register
							81 xx _h = CANopen stack message
							82 xx _h = CANopen stack message
							FF 20 _h = EEPROM error

Table 6 – format EMCY message

Examples:

00 00 00 00 01 05 50 00_h – Voltage error detected during initialization

00 00 00 00 01 81 80 00_h – Cross-tilt error on X axis

When all errors are corrected, the device enters the error-free state and transmits an emergency object with the error code ‘reset error / no error’ containing all 0 s.

6.8. LSS (Layer Setting Service, according to CiA305-DSP)

Layer setting services (LSS) and protocols are used to request or change the settings of three parameters of the physical layer, data link layer and application layer on a CANopen device via the CAN network. It is supported only in NMT stop mode or pre-operational mode.

The QG65D device is serviced as a CAN device, and a CAN master such as a PLC can detect and configure those three parameters with LSS:

- Node ID (→object 3000_h)
- CAN bus bit rate (→object 3001_h)
- LSS address: 128-bit number to identify each node uniquely, consisting of the vendor ID, product code, revision number and serial number with 32 bits each (→object 1018_h)

After changing parameters using LSS, a save action must be performed. Normally your LSS tool can be configured to perform an automatic save (store), as shown below:

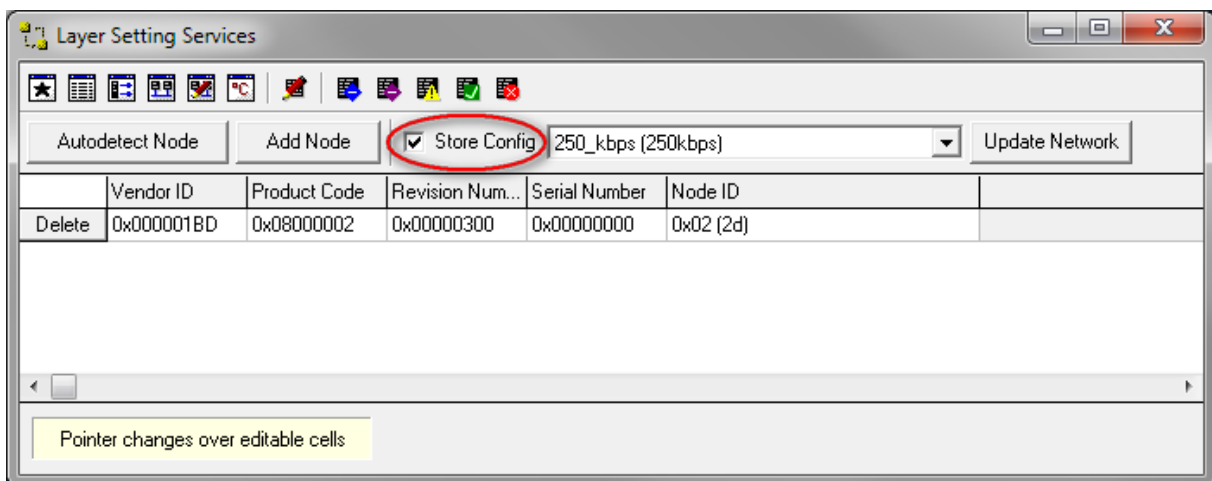

Figure 14 - LSS save action

6.9. Firmware management

If a firmware version is mentioned on the label, it is the factory-installed firmware number.



Figure 15 - Firmware version

It can also be requested with object 100A_h Manufacturer software version. The message format is "Vx.x.x" in ASCII, for example: V1.0.0.

The currently-installed firmware version might vary from the version on the sticker due to a firmware update. Always check the actual version in the object dictionary.

It will soon be possible to update the firmware via the DIS configuration tool. This tool can check the current firmware version in your device and upload the new firmware to the device. The user can upload the new firmware to the device by simply clicking a button (Figure 16).

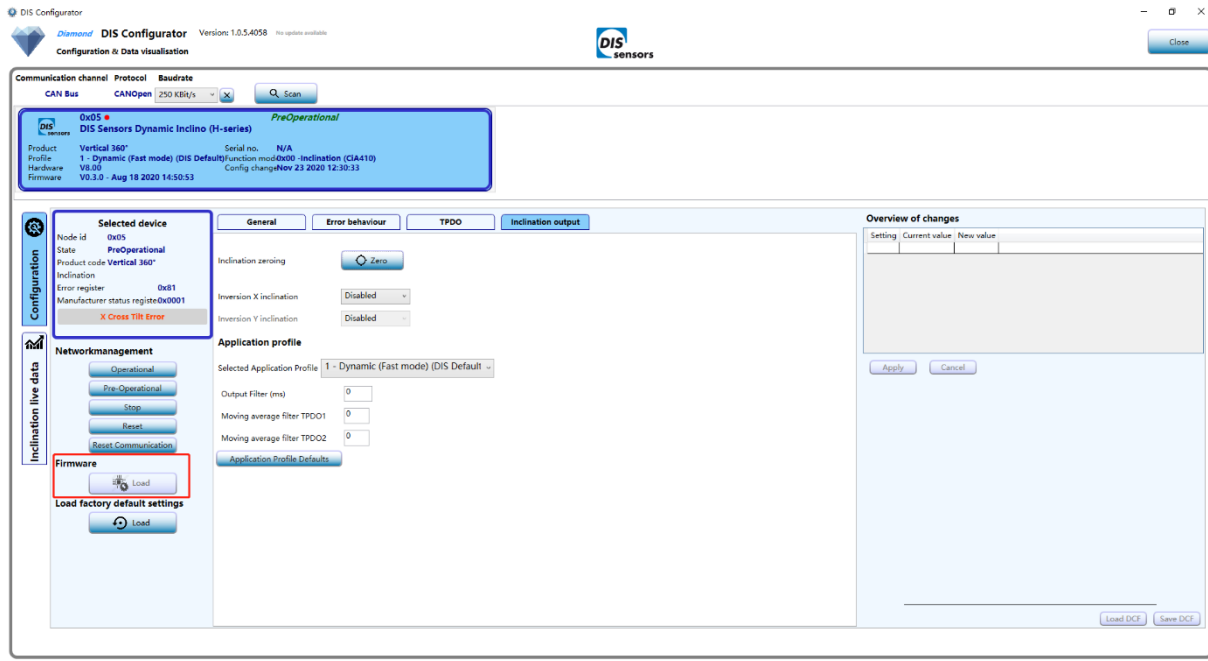

Figure 16 - Firmware update via configurator

The firmware release notes are available at www.dis-sensors.com under “downloads/user manuals”.

6.10. Load factory default settings

Factory reset or load factory default settings allows users to restore the device to its original manufacturer settings. The customer settings which were saved to the EEPROM will be overwritten by the factory default settings.

With **object 1011_h**, the factory default settings below can be restored. Customised products may have different factory default values, which may deviate from this manual. See the datasheet of your customized products for these customized factory default values.

DIS factory default - communication parameters

Parameters	Object	DIS standard default value
COB-ID SYNC	1005 _h	00000080 _h
Communication Cycle Period	1006 _h	00 _h
COB-ID EMCY	1014 _h	00000081 _h
Producer heartbeat time	1017 _h	2000 _d = 2000 ms
Error behaviour	1029 _h	00 _h = Switch to pre-operational
NMT Start-up behaviour	1F80 _h	00000000 _h = Start in operational
Node ID	3000 _h	01 _h
Baud Rate	3001 _h	03 _h = 250 kBit/s
Termination resistor	3003 _h	00 _h = Disabled
Error masks	301E _h	80001D40 _h

Table 7 – DIS standard factory default communication parameters

DIS standard factory default - application parameters

Parameters	Object	DIS standard default value
Function mode	3007 _h	00 _h – Inclination (CiA 410)
Moving Average filtering	3022 _h sub 07 _h and 300D _h	00 _h – Moving Average filtering OFF
Output Filter time	3022 _h sub 06 _h and 300E _h	00 _h – Output filter OFF
Operating parameters	6011 _h , 6021 _h	02 _h – DIS default measuring direction Pre-set enabled
Pre-set inclination value (Zero value)	6012 _h , 6022 _h	00 _h
Offset inclination value (Zero offset)	6013 _h , 6023 _h	Zero offset by calibration at factory. Various per sensor
Sub Range Limit	3032 _h	00 _h = Disabled

Table 8 – DIS standard factory default application parameters.

6.11. Zero adjustment

Zero adjustment allows users to compensate for mechanical offsets of a horizontally mounted 2-axis device or set a customised 0° position of a vertically mounted 1-axis sensor. The measured inclination value at the 0° position will be stored in the device as a permanent offset, which is used to calculate the actual inclination output of the device. The zero offset value can be read from → Object 6013_h, 6023_h Offset inclination value. (page 38)

Zero adjustment can be done in 2 ways and can be repeated at any time.

1. Via → Object 300Fh Zero adjustment.

The zero adjustment can be done for each axis separately or for all axes at the same time. Status information of the result is available from object 300Fh. The offset value will be stored permanently in the device without “save” to object 1010_h.

2. Via → Object 6012h, 6022h Pre-set inclination value.

To set the output of X/Y axis to 0°, write 0000_h to object 6012_h / 6022_h at your desired 0° position. The offset will be stored in Object 6013_h, 6023_h Offset inclination value. Those parameters must be saved to the device (→ 8.1.6 Object 1010_h Store parameters.)



1-axis ±180° sensors can be zero adjusted over the full range, the position of the male connector is at customer discretion. 2-axis ±30°/±90° sensors can only be zero adjusted in a horizontal position within an offset limit of ±5°.



After you load factory default settings, the sensor will be restored with the factory zero offset, which means the pre-set inclination value will be restored to 00_h, object 6013_h and 6023_h will be rewritten to a factory default value and you need to zero your sensor again.

6.12. EDS & DCF

The “Electronic Data Sheet” (EDS file) is a file format that describes the communication behaviour and the object dictionary entries of a device. In fact, it is a template. This allows tools such as CAN configuration tools to handle the device properly. The file format is described in CiA306 V1.3.0.

The EDS file contains all possible settings and functions for the device by describing the CAN object dictionary for the device to be set by CAN commands.

The EDS file does not contain a customer specific configuration description (the values of the object dictionary, such as the chosen baud rate, TPDO1 event time, Node ID, etc.). For this purpose, the customer can generate a DCF file (Device Configuration File) with all customer specific settings in the same format as the EDS file. The DCF file is in fact an emulation of the EDS file.

After loading the DCF file into the device, the settings can be stored permanently into the EEPROM. (→ 8.1.6 Object 1010_h Store parameters)

The EDS files are available at www.dis-sensors.com under “downloads”.

6.13. Mappable objects

Objects that can be mapped into TPDO message.

Index	Subindex	Type	Object name and description
1001 _h	00 _h	U8	Error register 00 _h – No error 81 _h – Error detected
1002 _h	00 _h	U8	Manufacturer status register
1013 _h	00 _h	U32	High Resolution Timestamp
301F _h			Manufacturer status register mapping
	00 _h	U8	Highest subindex supported
	01 _h	U8	Manufacturer Status Register bits 0 - 7
	02 _h	U8	Manufacturer Status Register bits 8 - 15
	03 _h	U8	Manufacturer Status Register bits 16 - 23
	04 _h	U8	Manufacturer Status Register bits 24 - 31
6010 _h	00 _h	S16	Inclination X-axis (longitudinal) Output X-axis. Inclination [°] with the resolution in object 6000 _{hse}
6020 _h	00 _h	S16	Inclination Y-axis (lateral) Output Y axis. Inclination [°] with the resolution in object 6000 _h
6401 _h			Sensor Outputs
	00 _h	U8	Highest subindex supported
	01 _h	S16	X acceleration [mg]
	02 _h	S16	Y acceleration [mg]
	03 _h	S16	Z acceleration [mg]
	04 _h	S16	X inclination scale ±180° [0.01°]
	05 _h	S16	Y inclination scale ±180° [0.01°]
	06 _h	S16	Reserved
	07 _h	S16	Reserved
	08 _h	S16	Reserved
	09 _h	S16	Reserved
	0A _h	S16	Temperature [0.1 °C]
	0B _h	S16	Reserved
	0C _h	S16	Reserved
	0D _h	S16	Reserved
	0E _h	U16	X inclination scale 0°-360° [0.01°]
0F _h	U16	Reserved	
6511 _h	00 _h	S16	Device Temperature [1°C]

Table 9 - Mappable objects

7. CANopen specification

The QG65N2 series of devices communicates with the CANopen interface according to CiA 301. The device profile CiA 410 is implemented. All parameters and measured values can be accessed by the Object dictionary. More knowledge of CANopen sensors can be found in our [Knowledgebase](#).

7.1. CANopen Communication Objects (COB)

A CANopen device contains a communication module that provides communication objects and the appropriate functionality to transport data items via the underlying network structure. In other words: objects that you send or receive from the device for different communication purposes.

The communication objects are described by the services and protocols. Objects we often use:

Common COBs	Description
SDO	Service Data Object provides direct access to object entries of a CANopen device's object dictionary
PDO	Process Data Object is used to transfer real-time data
NMT	Network Management object is used to execute network management services to initialize, monitor, restart or stop the sensor
SYNC	Synchronization object provides the basic network synchronization mechanism
EMCY	Emergency object is used to indicate internal errors
Heartbeat	Heartbeat is produced by the device to indicate its status. It is one of the error control services in CANopen.
LSS	Layer Setting Service (LSS) enables the LSS master to modify the LSS slaves' node-ID and to switch the entire network from one data rate to another.

Table 10 – Common communication objects

7.2. Predefined CAN-IDs

Every CAN message on the bus starts with a CAN-ID. A CAN device that uses 11-bit identifiers is commonly called CAN 2.0 A and a CAN device that uses 29-bit identifiers is commonly called CAN 2.0B. For CANopen sensors, DIS Sensors implements an 11-bit CAN-ID which consists of a 4-bit function code and 7-bit Node ID.

Examples:

Object SYNC has function code 0001b, resulting CAN-ID 000,1000,0000b=080h.

Object TPDO1 has function code 0011b, resulting CAN-ID 001,1000,0000b=180h.

CiA has pre-defined CAN-IDs for common CAN objects as below:

CAN objects	CAN-ID
NMT	000 _h
SYNC	080 _h
Emergency	080 _h + Node ID
TPDO1	180 _h + Node ID
TPDO2	280 _h + Node ID
SDO tx (server -> client)	580 _h + Node ID
SDO rx (client -> server)	600 _h + Node ID
Heartbeat	700 _h + Node ID

Table 11 – Predefined CAN-ID of common objects.

7.3. PDO (Reading sensor output)

The Process Data Object (PDO) is used to process real time data. The measured values such as inclination, temperature, etc. are sent with TPDOs. PDOs are transmitted in the NMT operational state only and may be transmitted when a mapped process data item changes.

A DIS device supports 2 TPDOs. In factory default mode, TPDO1 sends the sensor output, TPDO2 is disabled. The communication parameters of TPDOs can be configured with [object 1800_h and 1801_h](#). The data transmitted with TPDOs can be configured with TPDO mapping parameters [object 1A00_h and 1A01_h](#).

7.4. SDO (configuring Object Dictionary)

The Service Data Object (SDO) is used to set and request values from the object dictionary. There are three types of SDO services used to transmit data. In this context, the device is considered as a server (owner of the object dictionary) and communication is viewed from the server.

SDO Services	Description	SDO Request (600 _h + Node ID)	SDO Response (580 _h + Node ID)
SDO upload	Read from device Server -> Client	40 _h = Expedited Read	43 _h = Read reply 4 bytes 47 _h = Read reply 4 bytes 4B _h = Read reply 4 bytes 4F _h = Read reply 4 bytes
SDO download	Write to device Client -> Server	23 _h = Expedited Write, 4 Bytes 27 _h = Expedited Write, 3 Bytes 2B _h = Expedited Write, 2 Bytes 2F _h = Expedited Write, 1 Byte	60 _h = Write Reply
SDO abort transfer	Indicates error		80 _h = Error/Abort code

Table 12 - Expedited SDO transfer command specifier

[Common SDOs](#) to configure sensors and [SDO abort codes](#) can be found in the [knowledge base](#).

7.5. NMT state

CANopen devices are initialized, started, monitored, reset or stopped using NMT services. The NMT state of the device can be set by applications such as PLC software. Table 12 shows the communication objects that exist in each NMT state.

NMT State	PDO	SDO	SYNC	EMCY	Heartbeat	Description
Pre-operational	✗	✓	✓	✓	✓ 7F _h	Configuration mode: PDOs do not exist. This is the recommended mode for configuration of PDOs.
Operational	✓	✓	✓	✓	✓ 05 _h	Take care with configuration in this mode, as some objects are protected and may not be changed in this mode.
Stopped	✗	✗	✗	✗	✓ 04 _h	All communication is forced to stop except the heartbeat/node guarding.
Bootup	✗	✗	✗	✗	✓ 00 _h	Device is initialised with default power-on values

Table 13 – NMT states and communication objects

7.6. Object Dictionary (device parameters)

The object dictionary is a collection of data items that influence the behaviour of the application objects, the communication objects and the state machine used on this device. Each object is addressed using a 16-bit index and an 8-bit subindex.

Index Range	Object	Description
1000 _h – 1FFF _h	Communication profile area	Parameters for communication such as SDO, PDO, NMT etc.
2000 _h – 5FFF _h	Manufacturer-specific profile area	Parameters for device-specific features such as function mode, etc.
6000 _h – 9FFF _h	Application profile area	Parameters that are common for inclinometers.
Other	Reserved for factory use	Do not use

Table 14 – Structure of object dictionary

All parameters in the object dictionary can be accessed with SDOs.

See also 8. CAN Object dictionary overview.

8. CAN Object dictionary overview

8.1. Communication profile (Index 1000h - 1FFFh)

Index	Subindex	Data Type	Access	Object Name and description	Factory Default	Detail
1000 _h	00 _h	U32	r	Device type (QG65N2 complies with device profile CiA410)	0101019A _h – 1-axis inclination 0102019A _h – 2-axis inclination	
1001 _h	00 _h	U8	r	Error register 00 _h – No error 81 _h – Error detected	00 _h	8.1.1
1002 _h	00 _h	U8	r	Manufacturer status register	00000000 _h – No error	8.1.2
1003 _h				Predefined error field		8.1.3
	00 _h	U32		Number of errors. Range: 00 _h to FE _h	00 _h	
	01 _h ...FE _h	U32	r	Error Code	NA	
1005 _h	00 _h	U32	rw	COB-ID SYNC	00000080 _h	8.1.4
1006 _h	00 _h	U32	r	Communication cycle period	00000000 _h – No SYNC transmission	8.1.5
1008 _h	00 _h	VSTR	const	Manufacturer device name	DIS Sensors QGxxN2 CANopen (High acc.) DIS Sensors QGxxN2 CANopen (Std acc.)	
1009 _h	00 _h	VSTR	const	Manufacturer hardware version	Depends on sensor. e.g. "V8.0"	
100A _h	00 _h	VSTR	const	Manufacturer software version	Depends on sensor. e.g. "V1.0.0"	
1010 _h				Store parameters	Write "save" or "65766173 _h " to subindex	8.1.6
	00 _h	U8	const	highest subindex supported	04 _h	
	01 _h	U32	rw	Save all parameters		
	02 _h	U32	rw	Save communication parameters.		
	03 _h	U32	rw	Save application parameters		
	04 _h	U32	rw	Save manufacturer specific parameters		
1011 _h				Restore default parameters	Write "load" or "64616F6C _h " to subindex	8.1.7
	00 _h	U8	const	Highest subindex supported	04 _h	
	01 _h	U32	rw	Restore all parameters		
	02 _h	U32	rw	Restore communication parameters		
	03 _h	U32	rw	Restore application parameters		
	04 _h	U32	rw	Restore manufacturer specific parameters		
1013 _h	00 _h	U32	rw	High Resolution Timestamp	00 _h	
1014 _h	00 _h	U32	rw	COB-ID EMCY	00000081 _h (80 _h + Node ID)	8.1.8
1017 _h	00 _h	U16	rw	Producer heartbeat time	7D0 _h – 2000 ms	
1018 _h				Identity object		
	00 _h	U8	const	Highest subindex supported	04 _h	
	01 _h	U32	r	Vendor ID	000001BD _h	
	02 _h	U32	r	Product code	09000001 _h – 1-axis inclination 360° 09000002 _h = 2-axes inclination ±90° 09000003 _h = 2-axes inclination ±30°	
	03 _h	U32	r	Revision number	00010000 _h = V1.0.0	
	04 _h	U32	r	Serial number	e.g. 77542822 _h = 2002004-002 _d	
1020 _h				Verify configuration		8.1.9
	00 _h	U8	const	Highest subindex supported	02 _h	
	01 _h	U32	rw	Configuration date	number of whole days since 1-1-1984	
	02 _h	U32	rw	Configuration time	number of ms since midnight	
1029 _h				Error behaviour		8.1.10
	00 _h	U8	const	Highest subindex supported	02 _h	
	01 _h	U8	rw	Communication error 00 _h = switches to pre-operational 01 _h = does not change state 02 _h = switches to stopped 03 _h ... FF _h = reserved	00 _h	

Index	Subindex	Data Type	Access	Object Name and description	Factory Default	Detail
1800h	02h	U8	rw	Profile- or manufacturer-specific error 00h = switches to pre-operational 01h = does not change state 02h = switches to stopped 03h ... FFh = reserved	00h	
				TPDO1 communication parameter		8.1.11
	00h	U8	const	Highest subindex supported	05h	
	01h	U32	rw	COB-ID used by TPDO1 40000181h = TPDO1 enabled C0000181h = TPDO1 disabled	40000181h (CAN-ID of TPDO1: 180h + Node ID)	
	02h	U8	rw	Transmission type FFh = event-driven 01h = sync	FFh	
	03h	U16	rw	Inhibit time	0000h	
1801h	05h	U16	rw	Event timer	0064h = TPDO1 event time 100 ms	
				TPDO2 communication parameter		8.1.11
	00h	U8	const	Highest subindex supported	05h	
	01h	U32	rw	COB-ID used by TPDO2 40000281h = TPDO2 enabled C0000281h = TPDO2 disabled	C0000281h (CAN-ID of TPDO2: 280h + Node ID)	
	02h	U8	rw	Transmission type FFh = event-driven 01h = sync	FFh	
	03h	U16	rw	Inhibit time	0000h	
1A00h	05h	U16	rw	Event timer	0064h = TPDO2 event time 100 ms	
				TPDO1 mapping parameter		8.1.12
	00h	U8	rw	Number of mapped application objects in TPDO	01h = 1 axis ±180° 02h = 2 axes ±30°/±90°	
	01h	U32	rw	Mapping object1	60100010h	
	02h	U32	rw	Mapping object2	60200010h	
	03h	U32	rw	Mapping object3	00000000h	
1A01h	04h	U32	rw	Mapping object4	00000000h	
				TPDO2 mapping parameter		8.1.12
	00h	U8	rw	Number of mapped application objects in TPDO	00h = Disabled	
	01h	U32	rw	Mapping object1	64010110h	
	02h	U32	rw	Mapping object2	64010210h	
	03h	U32	rw	Mapping object3	64010310h	
1F80h	04h	U32	rw	Mapping object4	00000000h	
	00h	U32	rw	NMT Start-up behaviour 00000004h: start in state pre-operational 00000000h: start in state operational	00000000h	8.1.13

Table 15 - Communication Profile



To permanently save communication parameters in the EEPROM of the device, use only CAN Object 1010h, otherwise the changes will be lost after a power cycle. All indices and/or subindices not described in the table are reserved exclusively for factory use.

8.1.1. Object 1001_h Error register

This object indicates the type of a detected error. This is a part of the EMCY message (→6.7 Emergency message).

Bit	Error type	Example
0	Generic error	00 _h - No error (this bit is set to 1 whenever another error bit is set)
1	Current	03 _h
2	Voltage	05 _h
3	Temperature	09 _h
4	Communication error	11 _h
5	Device profile specific	21 _h
6	Reserved, always 0	
7	Manufacturer-specific	81 _h - Manufacturer error detected

Table 16 – Error register

8.1.2. Object 1002_h Manufacturer status register

This object defines the manufacturer error codes. Each bit represents a specific type of error. When an error is detected, the bit will be set to 1. This is a part of the EMCY message (→ 6.8 Emergency message).

Bit	Error
Bit 0	Inclination X axis (longitudinal) cross tilt error
Bit 1	Inclination Y axis (lateral) cross tilt error
Bit 2	Inclination X axis (longitudinal) out of range indication
Bit 3	Inclination Y axis (lateral) out of range indication
Bit 4	Temperature Under operational limit (e.g. T < -40°C, specified in the datasheet.)
Bit 5	Temperature Over operational limit (e.g. T > +85°C, specified in the datasheet.)
Bit 6	Actual power error (e.g. supply voltage too low)
Bit 7	Power error since last reset (memorized)
Bit 8	EEPROM Error
Bit 9	Flash Error
Bit 10	Sensor element Error
Bit 11	Watchdog Error
Bit 12	Error handler activated Error
Bit 13-31	Unused Error bits

Table 17 - Manufacturer error code

The error code can be mapped into the TPDO message via Object 301F_h.

E.g. (2 axis model)

Error code (Byte 3-7)	Error description
00 00 00 01	When Y tilts > ±45°, X axis is disabled, bit 0 is set to 1.
00 00 00 02	When X tilts > ±45°, Y axis is disabled, bit 1 is set to 1.
00 00 00 06 (0110)	When X tilts > ±90°, X is out of range and Y axis is disabled due to cross tilt error, bit 2 and bit 1 both set to 1.
00 00 00 09 (1001)	When Y tilts > ±90°, Y is out of range and X axis is disabled due to cross tilt error, bit 3 and bit 0 both set to 1.
00 00 00 0C (1100)	When X and Y both tilts > ±90°, bit 2 and bit 3 are set to 1.

Table 18 - Example manufacturer error code

8.1.1.3. Object 1003_h Predefined error field

This object provides an error history of the device. The error codes are saved in the subindex starting with 01_h. The most recent error is always shown on the top. These error codes are transmitted with the emergency object.

- Subindex 00_h indicates the number of existing errors that are recorded in the array starting at subindex 01_h.
- If an error is detected, the error code will be stored in subindex 01_h and higher. Same error code will also be sent via the emergency object. In doing so it provides an error history.

Subindex	Description	Value
00 _h	Number of errors detected	No error: 00 _h
01 _h	The latest error code	See 6.7 Emergency message
02 _h ... 10 _h	Oldest error - highest subindex A maximum of 16 errors (emergency messages) are stored.	

Table 19 - Predefined error field



Writing 00_h to subindex 00_h will delete the entire error history.

The error message in object 1003 is not the full EMCY message, it contains only the error code and the manufacturer-specific error.

Byte3	Byte2	Byte1	Byte0
Manufacturer-specific error (1002 _h)		Error Code (CiA301)	
Byte1	Byte0	Byte1	Byte0

Table 20 - message structure 1003_h

8.1.4. Object 1005h COB-ID SYNC message

The structure of the COB-ID of SYNC object is specified as below:

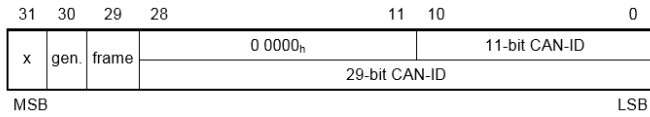

Default COB-ID is 00000080h, which means:

- 11-bit CAN-ID is valid by default
- CAN-ID of SYNC is 080h

8.1.5. Object 1006h Communication cycle period

This object defines the SYNC interval. The value must be supplied as a multiple of μ s. If the value is set to 0000 0000h the transmission of SYNC messages will be disabled.

8.1.6. Object 1010h Store parameters

Use this object to save the customised settings such as Node ID, baud rate, etc. to the internal EEPROM. User can store parameters in both NMT operational and pre-operational state.

Procedures:



- Write "save" to sub-index 01h = All parameters will be stored.
- Write "save" to sub-index 02h = Parameters of communication profile (Index 1000_h - 1FFF_h) will be stored.
- Write "save" to sub-index 03h = Parameters of application profile (Index 6000_h - 9FFF_h) will be stored.
- Write "save" to sub-index 04h = Parameters of manufacturer-specific profile (Index 2000_h-5FFF_h) will be stored.
- Write "save" in ASCII or "65766173h" have the same effect.



An NMT request or a new power cycle is required to enable the stored settings.

8.1.7. Object 1011_h Restore factory default parameters

Use this object to restore the factory default values for the parameters of the communication profile, device profile and application profile. The factory default values of standard DIS devices are specified in Table 7, Table 8 and the object dictionary overview tables. Customised devices may have different factory default values, which may deviate from this manual. See the datasheet of your customized product for these customized factory default values. You can restore the factory default in both NMT operational and pre-operational state.

Procedures:



- Write “load” to sub-index 01h = All parameters will be restored.
- Write “load” to sub-index 02h = Parameters of communication profile (Index 1000_h - 1FFF_h) will be restored.
- Write “load” to sub-index 03h = Parameters of application profile (Index 6000_h - 9FFF_h) will be restored.
- Write “load” to sub-index 04h = Parameters of manufacturer-specific profile (Index 2000_h-5FFF_h) will be restored.
- Write “load” in ASCII or “64616F6Ch” have the same effect.

 A direct NMT restart or new power cycle is required to enable the factory default settings after a “load”. Do not execute “save” before you restart the device, as this will cause the current working environment settings to overwrite (i.e. store) the default factory settings (see 8.1.6 above).

8.1.8. Object 1014_h COB-ID EMCY

This object configures the COB-ID for the EMCY write service. The factory default COB-ID of EMCY is 00000081_h, which indicates:

- EMCY exists (bit31=0)
- 11-bit CAN-ID is valid
- CAN-ID of EMCY is 81_h (default: 80_h + Node ID 01_h)

 It is not recommended to change the CAN-ID of EMCY to a different value.

8.1.9. Object 1020_h verify configuration

This object provides the downloaded configuration date and time. It is used by configuration tools to compare the current device configuration date with their DCF files and determine whether reconfiguration is necessary.

8.1.10. Object 1029_h error behaviour

This object configures the device to enter the selected NMT state when a serious failure is detected. By default, subindex 01h and 02h are both preconfigured with the default value of 00h, which means the device shall autonomously enter pre-operational state.

Subindex	Error type	Error behaviour
01h	Communication error	00h = Change to NMT state pre-operational (only if currently in NMT state Operational)
02h	Profile- or manufacturer-specific error	01h = No change of the NMT state 02h = Change to NMT state Stopped 03h ... FFh = reserved

Table 21 – Object 1029h error behaviour

Failures include the following communication errors:

- Bus-off state of the CAN interface
- Life guarding event with the state 'occurred' and the reason 'time out'
- Heartbeat event with state 'occurred' and the reason 'time out'
- Device internal failures

8.1.11. Object 1800h, 1801h TPDO communication parameter

The QG65D series device supports 2 TPDOs: object 1800h configures the communication parameters of TPDO1; object 1801h configures those of TPDO2.

Subindex	Description	Value
01h	Defines the COB-ID of TPDO Default CAN-ID of TPDO1 = 180h + Node ID. Default CAN-ID of TPDO2 = 280h + Node ID.	4000181h = Enable TPDO1 C000181h = Disable TPDO1
02h	TPDO transmission type Synchronous: TPDO is transmitted after the SYNC Event-driven: TPDO is transmitted at any time based on the occurrence of an internal event.	01h = synchronous FFh = event-driven (default)
03h	Inhibit time	0000h = Disabled
05h	Event timer defines the interval of TPDO. The value is defined as multiple of 1 ms.	0064h = TPDO1 event time 100 ms 0000h = Disabled.

Table 22 - TPDO communication parameter

8.1.12. Object 1A00h, 1A01h TPDO Mapping parameter

Object 1A00h contains the mapping parameters for TPDO1.

Object 1A01h contains the mapping parameters for TPDO2.

The value indicates the index, subindex of the mapped object, and the data length.

For example, with factory default settings:

- TPDO1 mapping parameter of a 1-axis $\pm 180^\circ$ inclinometer is configured as in Table 19
- TPDO1 mapping parameter of a 2-axis $\pm 30^\circ/\pm 90^\circ$ inclinometer is configured as in Table 20
- TPDO2 mapping is disabled by default.

1A00h	TPDO1 mapping parameter	Object description	
00h	Number of mapped application objects in TPDO1	01h	TPDO1 consists of value from only 1 object.
01h	Mapping object1	60100010h	Index: 6010h, subindex: 00h, data length: 10h=16bits. Inclination X-axis (longitudinal)

Table 23 – Default mapping parameters of TPDO1 1-axis $\pm 180^\circ$

1A00 _h	TPDO1 mapping parameter	Object description	
00 _h	Number of mapped application objects in TPDO1	02 _h	TPDO1 consists of value from 2 objects.
01 _h	Mapping object1	60100010 _h	Index: 6010 _h , subindex: 00 _h , data length: 10 _i =16bits. Inclination X-axis (longitudinal)
01 _h	Mapping object1	60200010 _h	Index: 6020 _h , subindex: 00 _h , data length: 10 _i =16bits. Inclination Y-axis (lateral)

Table 24 – Default mapping parameters of TPDO1 2-axis ±30°/±90°

TPDO mapping procedure

The following procedure must be used for re-mapping, which may take place during either of the NMT states Pre-operational and Operational.



Step	Description	Value example
1	Disable TPDO	1800 _h .01 _h = C0000181 _h 1801 _h .01 _h = C0000281 _h
2	Disable TPDO mapping	1A00 _h .00 _h = 00 _h 1A01 _h .00 _h = 00 _h
3	Modify mapping by changing the values of the corresponding subindices.	1A00 _h .01 _h = 60100010 _h 1A00 _h .02 _h = 60200010 _h 1A01 _h .01 _h = 64011010 _h
4	Enable mapping by setting subindex 00h to the number mapped objects.	1A00 _h .00 _h = 02 _h 1A01 _h .00 _h = 01 _h
5	Enable TPDO	1800 _h .01 _h = 40000181 _h 1801 _h .01 _h = 40000281 _h

Table 25 – Procedure for configuring TPDO mapping parameters

The TPDO mapping parameters varies according to the user-selected [Function Mode](#).

8.1.13. Object 1F80_h NMT start-up behaviour

This object configures the NMT start-up state. In factory default configuration, the device enters NMT Operational state after it passes all internal tests. In this state, device output will be sent with TPDO1, and a heartbeat with value “05_h” will be sent indicating that the sensor is now in “Operational” state. To have the device start instead in “Pre-operational” state, write “00000004_h” to this object.

Value	Description
00000000 _h	Start in state Operational (default setting for DIS devices)
00000004 _h	Start in state Pre-operational

Table 26 – NMT start-up state configuration

8.2. Manufacturer-specific profile (2000_h - 5FFF_h)

Index	Subindex	Data type	Access	Object name and description	Factory default	Detail
3000 _h	00 _h	U8	rw	Node ID (Range: 01 _h - 7F _h)	01 _h	
3001 _h	00 _h	U8	rw	Baud Rate 00 _h = 1000 kBit/s 01 _h = 800 kBit/s 02 _h = 500 kBit/s 03 _h = 250 kBit/s 04 _h = 125 kBit/s 05 _h = 100 kBit/s 06 _h = 50 kBit/s 07 _h = 20 kBit/s 08 _h = 10 kBit/s	03 _h	
3003 _h	00 _h	U8	rw	CAN bus termination resistor 120 Ω 00 _h : Disable 01 _h : Enable	00 _h	4.4
3007 _h	00 _h	U8	rw	Function Mode 00 _h = Mode 0 01 _h = Mode 1 02 _h = Mode 2 03 _h = Mode 3 04 _h and 05 _h reserved 06 _h = Mode 6 07 _h = Mode 7 r FF _h = Mode FF (user defined mode)	00 _h	8.2.1
300D _h				Moving average filter		8.2.6
	00 _h	U8	r	Highest subindex supported		
	01 _h	U8	rw	Moving average number N for TPDO 1	00 _h	
	02 _h	U8	rw	Moving average number N for TPDO 2	00 _h	
300E _h	00 _h	U16	rw	Output filter	00 _h	8.2.5
300F _h	00 _h	U8	rw	Zero adjustment Inclination 01 _h Start zero adjustment X-axis 02 _h Start zero adjustment Y-axis 03 _h Start zero adjustment X and Y axis	00 _h	8.2.2
3014 _h	00 _h	U8	rw	Lowpass filter (2nd order Bessel cut-off frequency 10Hz) 00 _h = OFF , 01 _h = ON	01 _h	8.2.7
301E _h	00 _h	U32	rw	Manufacturer status register error mask mask which bits will trigger the manufacturer-specific error behaviour.		8.2.3
301F _h				Manufacturer status register mapping		8.2.4
	00 _h	U8	r	Highest subindex supported		
	01 _h	U8	r	Manufacturer Status Register bits 0 - 7		
	02 _h	U8	r	Manufacturer Status Register bits 8 - 15		
	03 _h	U8	r	Manufacturer Status Register bits 16 - 23		
	04 _h	U8	r	Manufacturer Status Register bits 24 - 31		
3032 _h				Sub Range Limits		8.2.8
	00 _h	U8	r	Highest subindex supported		
	01 _h	S16	r	Lower Sub Range Limit	00 _h	
	02 _h	S16	r	Upper Sub Range Limit	00 _h	

Table 27 – Application-specific profile



To permanently save application-specific parameters in the EEPROM of the device, use only CAN Object 1010h, otherwise the changes will be lost after a power cycle. All indices and/or subindices not described in the table are reserved exclusively for factory use.

8.2.1. Object 3007_h Function mode

Use this object to select a function mode (→ 6.4. Function mode).

Access	Value	Function Mode	Description
rw	00 _h	Mode 0	Inclination (CiA410)
rw	01 _h	Mode 1	Inclination (CiA410) alternative orientation (X and Y swapped, X and Y inverted)
rw	02 _h	Mode 2	Inclination (CiA410) + Temperature
rw	03 _h	Mode 3	Acceleration (3 axes) (Pure acceleration without dynamic effects compensation)
		Mode 4-5	Reserved
rw	06 _h	Mode 6	Inclination (compatible with QG65 CAN firmware v4B)
rw	07 _h	Mode 7	Inclination (compatible with QG65N CAN firmware v6)
r	FF _h	Mode FF	User defined mode (Output defined by user)

Table 28 - function mode

8.2.2. Object 300F_h Zero adjustment Inclination

To perform a zero adjustment, write the corresponding value to subindex 00_h (→ 6.11 Zero adjustment).

Write to 300F _h 00 _h		Response by reading 300F _h 00 _h
01 _h	Start zero adjustment X-axis - inclination	00 _h = Successful; FF _h = Failed
02 _h	Start zero adjustment Y axis - inclination	00 _h = Successful; FE _h = Failed
03 _h	Start zero adjustment X and Y axis - inclination	00 _h = Successful; FD _h = Failed

Table 29 – Object 300F_h entries description

8.2.3. Object 301E_h Manufacturer status register error mask

Use the error mask to select the error bit in object 1002_h that triggers the manufacturer-specific error behaviour. Set this bit to 1 to trigger the error behaviour, or 0 to ignore the error.

Bit	Error
0	Inclination X axis (Longitudinal) Cross Tilt Error
1	Inclination Y axis (Lateral) Cross Tilt Error
2	Inclination X axis (Longitudinal) Out of Range indication
3	Inclination Y axis (Lateral) Out of Range indication
4	Temperature under operational Limit (e.g. T < -40°C, specified in the datasheet.)
5	Temperature over operational Limit (e.g. T > +85°C, specified in the datasheet.)
6	Actual power error (e.g. Supply voltage too low)
7	Power error since last reset (memorized)
8	EEPROM error
9	Flash error
10	Sensor element error
11	Watchdog error
12	Error handler activated error
13 ~ 30	Unused error bits
31	ON/OFF sending of EMCY message '0x8000 Monitoring' at every change of the manufacturer status register bits.

Table 30 – object 1002_h Error bit

The factory default value is 80001D40_h (100000000000000000111010100000_b), which includes following errors:

- Bit 6: Actual power error.
- Bit 8: EEPROM error
- Bit 10: Sensor element error
- Bit 11: Watchdog error
- Bit 12: Error handler activated error
- Bit 31: Send EMCY message

The error behaviour is set via → Object 1029_h error behaviour.

8.2.4. Object 301F_h Manufacturer status register mapping

Use object 301F_h to map the manufacturer error code (→ 8.1.2 Object 1002_h Manufacturer status register) into the TPDO messages.

Subindex	Manufacturer status register mapping
00h	Highest subindex supported
01h	Manufacturer status register bits 0 - 7
02h	Manufacturer status register bits 8 - 15
03h	Manufacturer status register bits 16 - 23
04h	Manufacturer status register bits 24 - 31

Table 31 – Manufacturer status register mapping object

For example, to get the first 8 bits of the manufacturer error code in the TPDO output, set the TPDO1 mapping parameters to 301F0108_h (→ Object 1A00_h, 1A01_h TPDO Mapping parameter).

8.2.5. Object 300E_h Output filter

Use object 300E_h to set the filter time τ for a 1st order LPF for all sensing axes (→6.3.3 Digital filters). The cut-off frequency is calculated using this formula: $F_{-3\text{ dB}} = 1/2\pi\tau$.

τ is the time-constant with a value range of 0ms (off) ~ 10000 ms.

8.2.6. Object 300D_h Moving average filter TPDO1 and TPDO2

Use this object to set the average number N for the moving average filter for the TPDOs (→6.3.3 Digital filters).

Value Range	Description
00h	Moving average filter disabled (factory default)
01h	Moving average filter disabled.
02h – 0A _h	Output is averaged with the last 20 ms – 100 ms samples.

Table 32 – moving average filter TPDO

8.2.7. Object 3014h Lowpass filter

A 2nd order Bessel filter with a cut off frequency of 10Hz. The frequency cannot be changed. It can be turned ON/OFF. (→6.3.3 Digital filters).

Value Range	Description
00h	Off
01h	On

Table 33 – 2nd order Bessel LPF

8.2.8. Object 3032h Sub Range Limits

Use this object to change the measuring range of the sensor.

Sub index	Name	Value
01h	Lower Sub Range Limit	0 = sub range disabled -6000d = -60°
02h	Upper Sub Range Limit	0 = sub range disabled +6000d = +60°

e.g., Lower sub range limit= -6000_d, Upper sub range limit = +6000_d will set the measuring range to -60° to +60°.



This object only applies to device type 0x90000001 and 0x90000004.

8.3. Standardized device profile (6000h – 9FFFh) (CiA410)

Index	Subindex	Type	Access	Object name and description	Factory default	Detail
6000 _h	00 _h	U16	r/w	Resolution 10 _d =0.01°, 100 _d =0.1°, 1000 _d =1.0°	10 _d	8.3.1
6010 _h	00 _h	S16	r	Inclination X-axis (longitudinal) Output X-axis. Inclination [°] with the resolution in object 6000 _h	No	
6011 _h	00 _h	U8	rW	Operating parameter for Inclination X-axis (longitudinal) bit0 = 1: inverted; 0: normal bit1 = 1: pre-set value included; 0: pre-set value excluded.	02 _h	8.3.2
6012 _h	00 _h	S16	rW	Pre-set Inclination X-axis	0000 _h	8.3.3
6013 _h	00 _h	S16	rW	Offset Inclination X-axis	0000 _h	8.3.4
6020 _h	00 _h	S16	r	Inclination Y-axis (lateral) Output Y axis. Inclination [°] with the resolution in object 6000 _h	No	
6021 _h	00 _h	U8	rW	Operating parameter for Inclination Y-axis (lateral) bit0 inversion = 1: inverted; 0: normal bit1 scaling = 1: enable; 0: disable	02 _h	8.3.2
6022 _h	00 _h	S16	rW	Pre-set Inclination Y-axis	0000 _h	8.3.3
6023 _h	00 _h	S16	rW	Offset Inclination Y-axis	0000 _h	8.3.4
6401 _h				Sensor Outputs		8.3.5
	00 _h	U8	r	Highest subindex supported	0F _h	
	01 _h	S16	r	X acceleration [mg]		
	02 _h	S16	r	Y acceleration [mg]		
	03 _h	S16	r	Z acceleration [mg]		
	04 _h	S16	r	X inclination scale ±180° [0.01°]		
	05 _h	S16	r	Y inclination scale ±180° [0.01°]		
	06 _h	S16	r	Reserved		
	-					
	09 _h					
	0A _h	S16	r	Temperature [0.1 °C]	Realtime e.g. 251h	
	0B _h	S16	r	Reserved		
	-					
	0D _h					
	0E _h	U16	r	X inclination scale 0°-360° [0.01°]		
	0F _h	U16	r	Reserved		
6511 _h	00 _h	S16	r	Device Temperature [1°C]	No	

Table 34 - Standardized device profile



To permanently save application-specific parameters permanent in the EEPROM of the device, use only CAN Object 1010h, otherwise the changes will be lost after a power cycle.

8.3.1. Object 6000_h Resolution

The resolution of the inclinometer can be configured with object 6000_h. The QG65N2 inclinometer has a default resolution of 0.01°.

8.3.2. Object 6011_h, 6021_h Operating parameter

Use the operating parameter to set the +/- direction of measurement, and whether the pre-set value should be calculated.

Index	Subindex	Value			
6011 _h 6021 _h	00 _h	Bit 0	Inversion	0	Disable (DIS default)
					1
		Bit 1	Pre-set	0	Disable
				1	Enable

Table 35 - Operating parameter

If Pre-set is enabled, the actual output will be calculated with the pre-set value in Object 6012_h and 6022_h. (see below).

If Pre-set is disabled, the actual output is the unscaled physically measured inclination value.

8.3.3. Object 6012_h, 6022_h Pre-set inclination value

Use these objects to store pre-set inclination values for the X and Y axis at a certain position, with the resolution given in object 6000_h. The outputs will be then adjusted to the stored pre-set value. The offset is stored in Object 6013_h, 6023_h Offset inclination value. They will be restored 00_h after you Load the default setting.

Index	Value	Example
6012 _h	Pre-set inclination X-axis	0000 _d - 0°
6022 _h	Pre-set inclination Y axis	0100 _d - 1°

Table 36 – Object 6012_h/6022_h Pre-set inclination value



2-axis ±30°/±90° sensors can only be pre-set in a horizontal position within an offset limit of ±5°.

8.3.4. Object 6013_h, 6023_h Offset inclination value

These objects store the offset inclination values for the X and Y axis after the pre-set is done. They will be restored to the offset value by the zero calibration at factory after you Load the default setting.

Index	Value	Example
6013 _h	Pre-set inclination X-axis	-9007 _d (1-axis Sensor pre-set at -90.07° position)
6023 _h	Pre-set inclination Y axis	+0200 _d (2-axis Sensor pre-set at Y=+2.00° position)

Table 37 – Object 6013_h/6023_h Offset inclination value

8.3.5. Object 6401_h Sensor outputs

Various types of outputs are stored in object 6401_h. These values can be mapped into TPDOs (→8.1.12 Object 1A00_h, 1A01_h TPDO Mapping parameter).

Subindex	Output Types	Description
00 _h	U8	Highest subindex supported
01 _h	S16	X acceleration [mg]
02 _h	S16	Y acceleration [mg]
03 _h	S16	Z acceleration [mg]
04 _h	S16	X inclination scale ±180° [0.01°]
05 _h	S16	Y inclination scale ±180° [0.01°]
06 _h	S16	Reserved
–		
09 _h		
0A _h	S16	Temperature [0.1 °C]
0B _h	S16	Reserved
–		
0D _h		
0E _h	U16	X inclination scale 0°-360° [0.01°]
0F _h	U16	Reserved

Table 38 – Sensor outputs

8.4. Data type

Data types used in the application layers are explained in the following table.

Data type	Definitions
U8	Unsigned 8-bit number (0 – 255 _d)
U16	Unsigned 16-bit number (0 – 65535 _d)
U32	Unsigned 32-bit number (0 – 4294967295 _d)
S8/Integer 8	Signed integer 8-bit number (-128 _d – +127 _d)
S16/Integer 16	Signed integer 16-bit number (-32768 _d – +32767 _d)
S32/Integer 32	Signed integer 16-bit number (-2147483648 _d – +2147483647 _d)
VSTR	Visible String

Table 39 - Data type

9. Configuration tool

The QG65N2 CANopen Inclinometer can be easily configured using DIS configurator set CAN developed by DIS Sensors. The tool also displays live data from the sensor. The configuration tool consists of a configuration kit and PC software. The configuration kit can be ordered separately, and the software can be downloaded from our website.

The minimum display resolution for the PC application is 1360x768p.

9.1. Configuration kit

DIS configurator set CAN comprises:

- Item 1: USB-CAN dongle. (Peak USB-CAN IPEH Interface adaptor)
- Item 2: CAN power box with power adapter connection.
- Item 3: 0.3 m CAN cable for connecting the sensor.
- Item 4: Power adaptor. (Figure 18)

(the power adaptor is an EU adaptor, user in regions might need a convertor which is not included.)



Figure 17 - Connection of DIS configurator set CAN

The USB-CAN dongle (item 1) provides the communication between USB and CAN interface. Note that DIS has modified the Peak USB-CAN IPEH Interface adaptor to forward a 5 V power supply to the CAN power box (item 2). If a standard (unmodified) Peak USB-CAN adaptor is used, the included power adaptor (item 4) must be used.

The CAN power box (item 2) provides the voltage supply to the sensor devices. When only 1 sensor is connected, it can be powered via the USB-CAN dongle (item 1) by the 5 V USB power. If more than 1 sensor is connected, then the power adaptor (item 4) must be used instead. This power adaptor can support up to 32 dynamic Inclinometers from DIS Sensors.

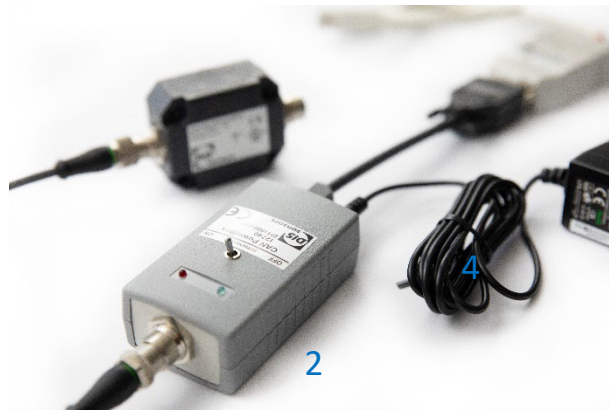



Figure 18 - Power adapter for the CAN power box

The CAN power box is also equipped with a switch to control the internal CANbus termination resistor within the CAN power box. The label clearly shows “on” and “off”.



Figure 19 - CAN power box

Two LEDs on the CAN power box indicate the power status. The green LED (connection indication) will be lit when it is connected correctly to the PC. The red LED (current overload indication) will be lit when the USB port is overloaded (max. 250 mA) to protect your PC or laptop. If you use the power adapter to supply the CAN power box, then the internal power supply and the current overload protection are disabled.

 If the CAN configurator is not used ‘stand-alone’ (i.e. only configurator + DIS sensor) but is connected to a powered CANbus system, then this CANbus system must be powered with $V_{cc} > 20$ V dc. Otherwise, the USB / DIS configurator will have to supply power to the entire CAN system chain, which can potentially harm the PC and connected items.

 DIS configurator set CAN will supply 18Vdc on V_{cc} and Gnd to the connected CAN systems/CAN sensors. Connecting sensors from other brands could potentially harm the equipment.

 The configuration tool can be loaned on request free of charge for pilot testing.

 DIS configurator set CAN may be used in an ambient temperature range of +10 °C to +50 °C without power adaptor, or 0 °C to +40 °C with power adaptor.

9.2. PC software

The PC software and a detailed manual can be download from the DIS website free of charge. The software provides a portal for both sensor configuration and live data monitoring. The description in this chapter is based on the first

released version. The changes will only be updated in the separate manual for the configurator, which you can also [download](#) from the DIS website.

Key features:

- **Sensor detection.** Click , the software will scan the CAN bus and find the connected sensors. Basic information such as product name, serial number, etc. will be shown as in Figure 20.

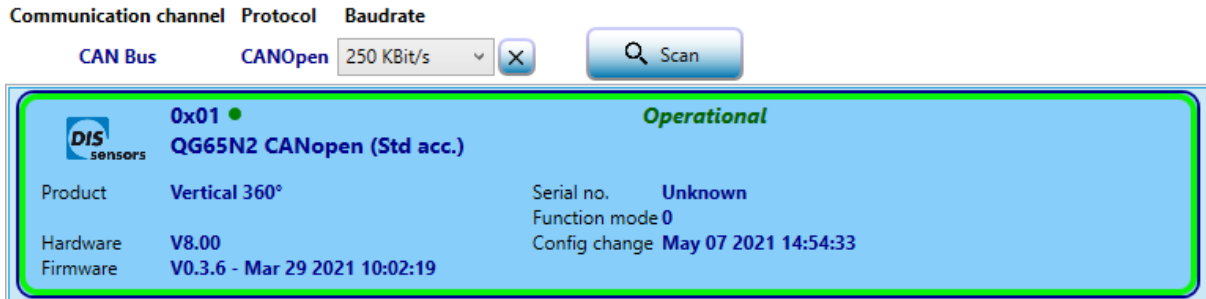

Figure 20 - Sensor detection

- Click on the displayed sensor to show a detailed configuration panel.

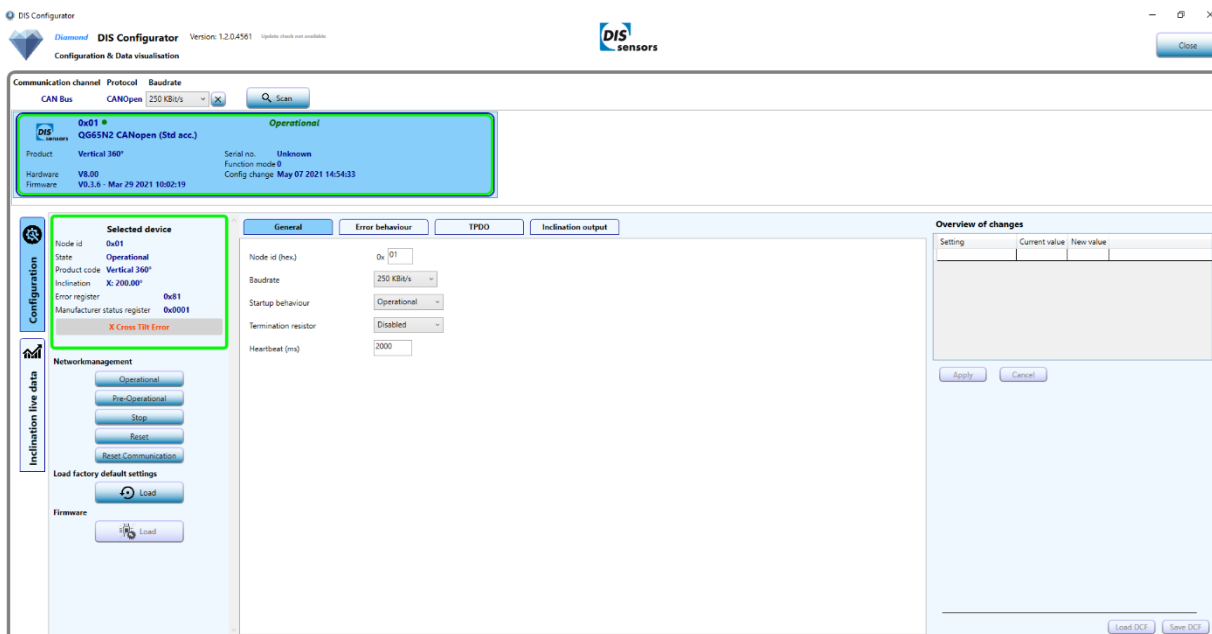

Figure 21 - Configuration panel

- The configurator keeps track of all changes you have made. Click the Apply button to save the changes to the sensor device. This can take a little time, after which the new settings will take effect.

Overview of changes

Setting	Current value	New value	
Function mode	00	01	
Baudrate	250 KBit/s	125 KBit/s	
Heartbeat (ms)	2000	1500	

Apply Cancel

Figure 22 - Overview of changes

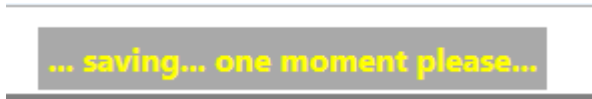

Figure 23 - Saving the changes.

- General configuration, Error behaviour, TPDO parameters and parameters for inclination output can easily be configured here.

General Error behaviour TPDO Inclination output

Node id (hex.) 0x 01

Baudrate 250 KBit/s ▾

Startup behaviour Operational ▾

Termination resistor Disabled ▾

Heartbeat (ms) 2000

Figure 24 - General configuration

General
Error behaviour
TPDO
Inclination output

General communication error settings:

Error behaviour: Switches to Pre-operational

Manufacturer specific error settings

Error behaviour: Switches to Pre-operational

Error masks :

- X Cross Tilt Error
- Y Cross Tilt Error
- X Out Of Range
- Y Out Of Range
- Temperature Under Reach
- Temperature Over Reach
- Actual Power Error
- Since Last Reset Power Error
- Eeprom Error
- Flash Error
- Sensor Error
- Watchdog Error
- Error Handler
- Send Emergency

Figure 25 - Error behaviour

General
Error behaviour
TPDO
Inclination output

TPDO1 Transmission

Transmission type: Event-mode

Event time (ms):

TPDO2 Transmission

Transmission type: Event-mode

Event time (ms):

Automatic TPDO Mapping (TPDO Presets)

Function mode: 0x00 -Inclination (CiA410)

Manual TPDO1 mapping

Enabled:

Object 1: 60100010 : Inclination X

Object 2: 00000000 : <none>

Object 3: 00000000 : <none>

Object 4: 00000000 : <none>

Manual TPDO2 mapping

Enabled:

Object 1: 00000000 : <none>

Object 2: 00000000 : <none>

Object 3: 00000000 : <none>

Object 4: 00000000 : <none>

Flexible configuration for the measuring axis, and output type (inclination/acceleration)

Figure 26 - TPDO mapping parameters in configuration panel

The PC software supports all TPDO mapping options, including 0-360° output. This output can therefore be used by a pilot customer, as 0-360° values are transferred in the TPDO message. Device profile inclinations ±30°, ±90° and ±180° are visible only in the live data tab.

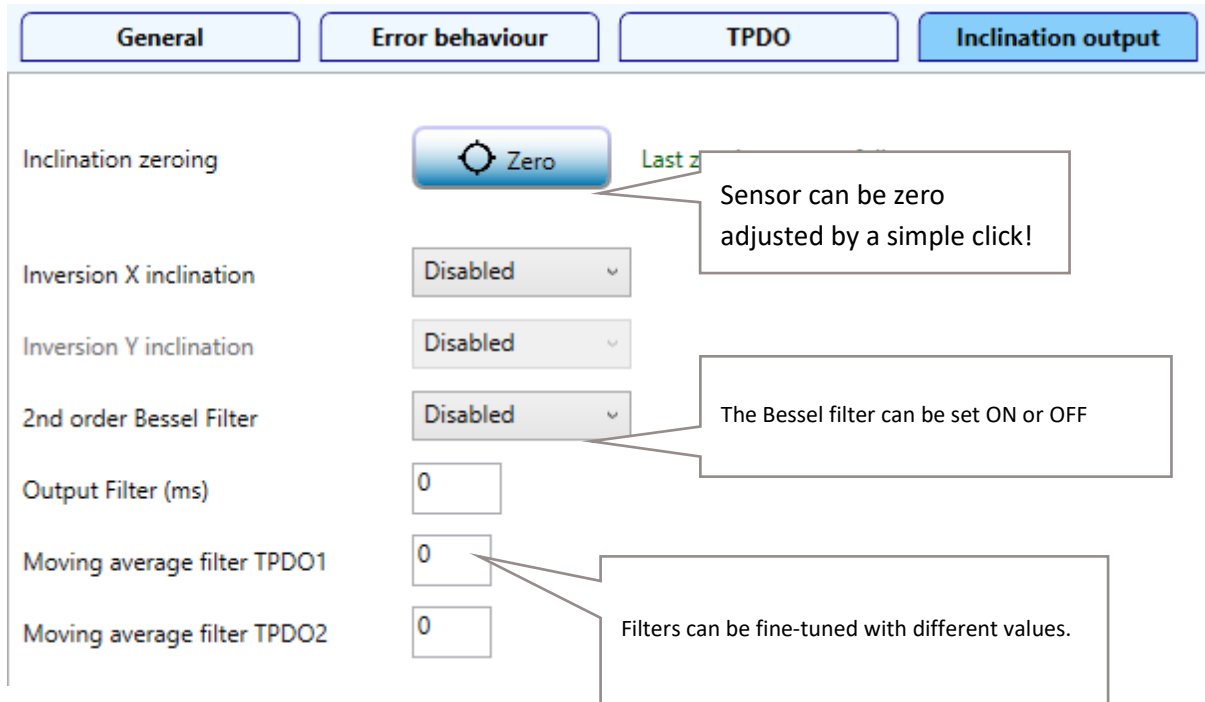

Figure 27 - Application profiles in configuration panel

- The "Live data" tab shows the real-time sensor outputs. The chart can also be c as an image.

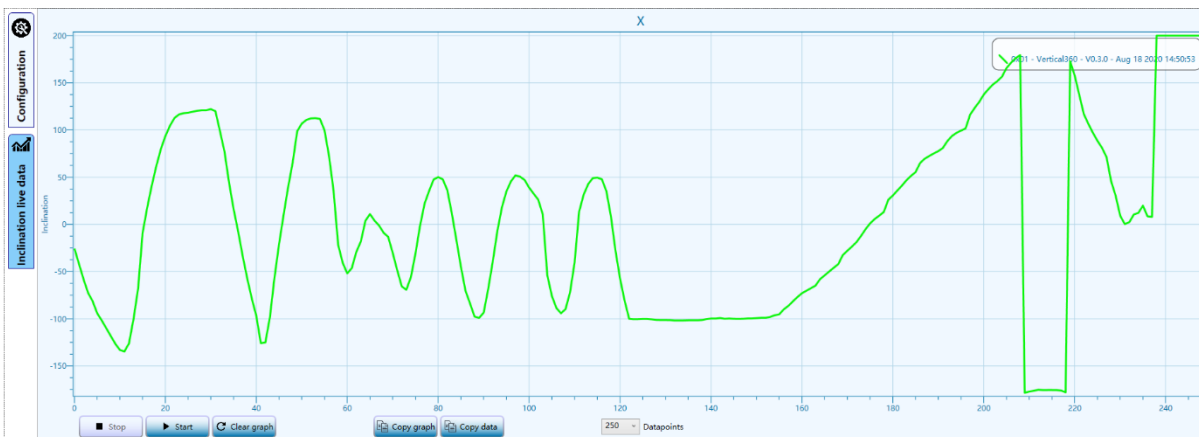

Figure 28 - Live data

- Future versions of this software will support upgrading of the firmware.

The screenshot displays the DIS sensors web interface. On the left, there are two vertical navigation tabs: 'Configuration' (with a gear icon) and 'Inclination live data' (with a bar chart icon). The main content area is divided into several sections:

- Selected device:** A box containing device details: Node id **0x05**, State **PreOperational**, Product code **Vertical 360°**, Inclination, Error register **0x81**, and Manufacturer status register **0x0001**. Below this is a red error message: **X Cross Tilt Error**.
- Networkmanagement:** A section with five buttons: Operational, Pre-Operational, Stop, Reset, and Reset Communication.
- Firmware:** A section with a button labeled 'Load' next to a microchip icon. This section is highlighted with a red border.
- Load factory default settings:** A section with a button labeled 'Load' next to a circular refresh icon.

Figure 29 - Firmware update

10. Abbreviations and definitions

CAN	Controller area network
CAN-ID	CAN identifier
COB	Communication object
COB-ID	COB identifier
CRC	Cyclic redundancy check
CiA	CAN in Automation
DOF	Degrees of freedom
EDS	Electronic data sheet
EMCY	Emergency
LPF	Low-Pass Filter
MEMS	Microelectromechanical system
NMT	Network Management
PDO	Process Data Object
SDO	Service Data Object
SYNC	Synchronization
TPDO	Transmit PDO

11. Normative references

CiA301	CANopen application layer and communication profile. Version: 4.2.0
CiA303-1	Cabling and connector pin assignment. Part 1: Cabling and connector pin assignment. Version: 1.9.0
CiA305-DSP	Layer setting services (LSS) and protocols, draft standard proposal
CiA306	Electronic data sheet specification for CANopen V1.3.0
CiA410	Device profile for inclinometer. Version: 1.3.0
IEC 61076-2-101	Connectors for electronic equipment - Part 2-101: Circular connectors – Detail specification for circular connectors M8 with screw- or snap-locking, M12 with screw locking for low voltage applications