

NOTE. ROD-EYE ORIENTATION NOT GUARANTEED

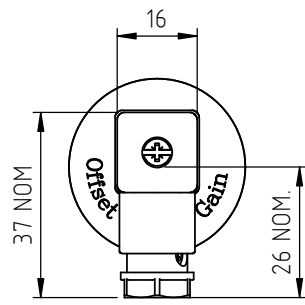

IP65 CONNECTOR
DIN 43650 C
(CODE 'J')

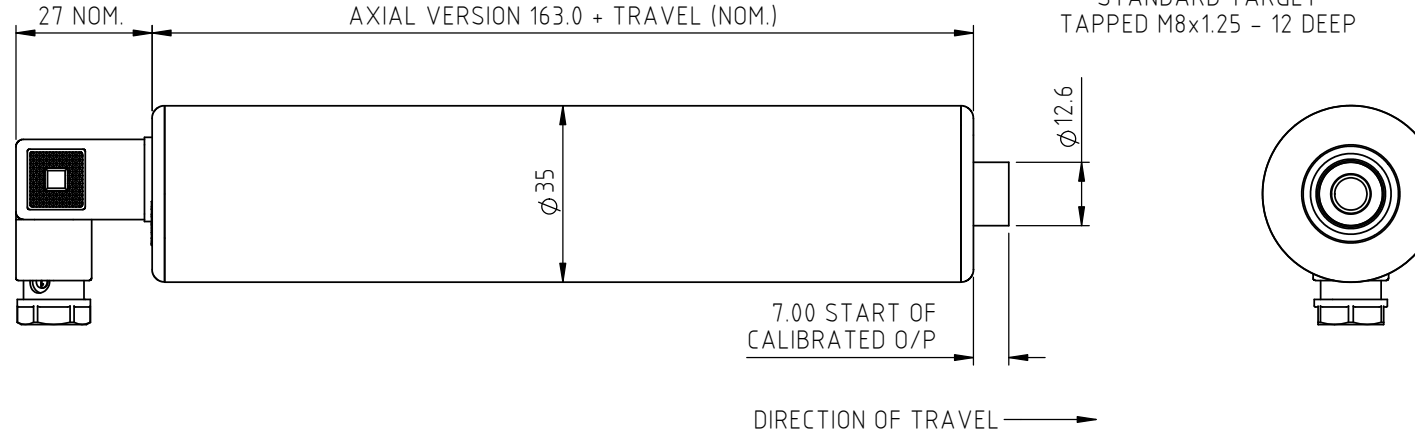

ELECTRICAL OPTIONS/ SPECIFICATIONS	
OUTPUT	SUPPLY (NOM)
'A' 0.5 - 4.5V RATIOMETRIC	5V
'B' ±5V	±15V
'C' 0.5 - 9.5V	24V
'D' ±10V	±15V
'G' 0.5 - 4.5V	24V
SUPPLY CURRENT 12MA TYP. 20MA MAX.	
'E' 4 TO 20MA 2-WIRE	24V (18V MIN.)
'F' 4 TO 20MA SINK†	24V
'H' 4 TO 20MA SOURCE‡	24V
† OUTPUT COMPLIANCE 5-28V	
‡ DRIVE 300Ω MAXIMUM TO 0V	

CONNECTIONS:	CABLE	CONNECTOR
+VE	3-CORE RED	4-CORE RED :1
0V	BLACK	GREEN :3
-VE	-	YELLOW :4 O/P 'B' & 'D'
OUTPUT	WHITE	BLUE :2
BODY	SCREEN	SCREEN :4 NOT O/P 'B' & 'D'

CABLE: 0.2mm², O/A SCREEN, PUR JACKET. O/D; 3-CORE: Ø4mm, 4-CORE: Ø4.6mm, SUPPLIED WITH 50cm OR REQUIRED LENGTH IN cm. e.g. 'L50' CONNECTORS; MAXIMUM CONDUCTOR CROSS SECTION 0.75mm²

RANGE OF DISPLACEMENT FROM 0-5mm TO 0-800mm e.g.76, IN INCREMENTS OF 1mm
BODY MATERIAL:- STAINLESS STEEL.

FURTHER OPTIONS:
SINGLE PAIR OF BODY CLAMPS 'P'
TWO PAIRS OF BODY CLAMPS 'P2'
SPRING RETURN PUSH-ROD, TRAVEL ≤300mm
RETURN TO EXTENDED POSITION (CODE 'R')
RETURN TO RETRACTED POSITION (CODE 'S')
PUSH-ROD FREE (CODE 'V') - NOT AVAILABLE WITH SPRUNG OPTIONS.
GAIN AND OFFSET ADJUSTMENTS NOT AVIALBLE WITH RADIAL BODY, CODE 'lxx' AND 'K' OPTIONS.

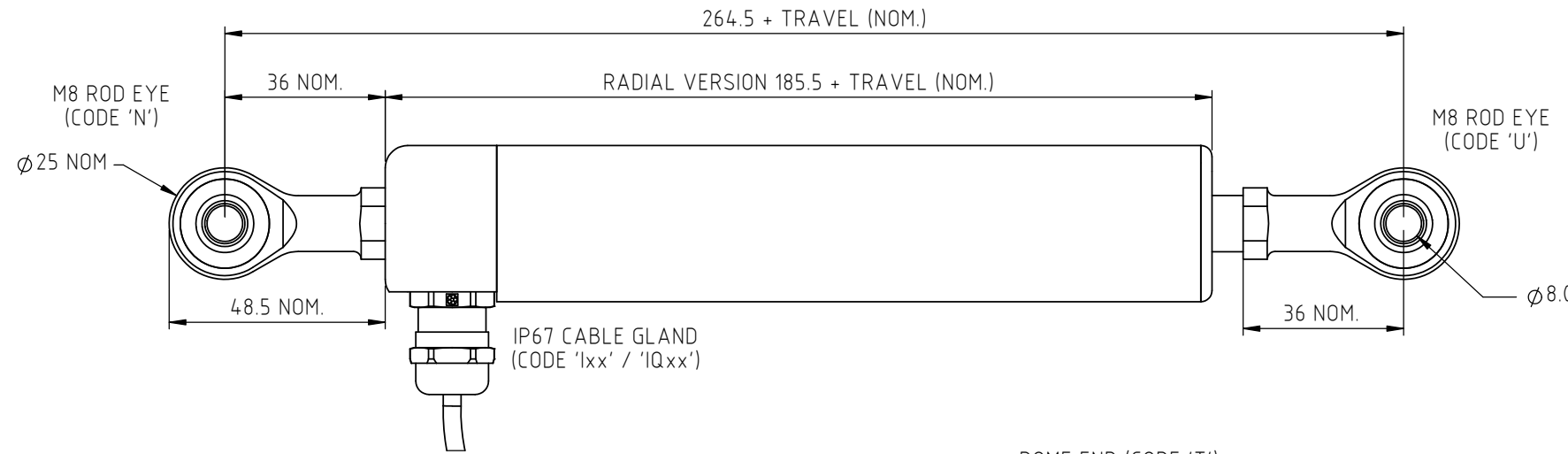
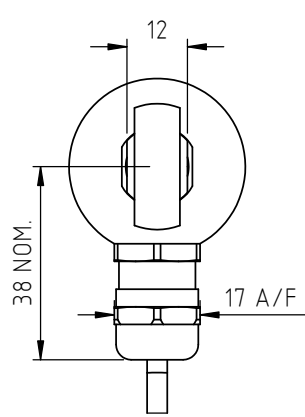

M8 ROD EYE
(CODE 'N')

IP67 CABLE GLAND
(CODE 'lxx' / 'lQxx')

M8 ROD EYE
(CODE 'U')

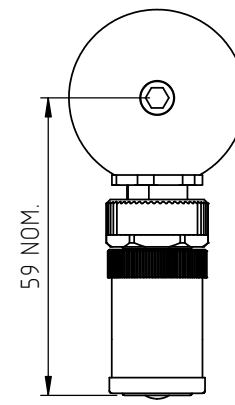

IP67 M12 CONNECTOR
IEC 60176-2-101
(CODE 'K')

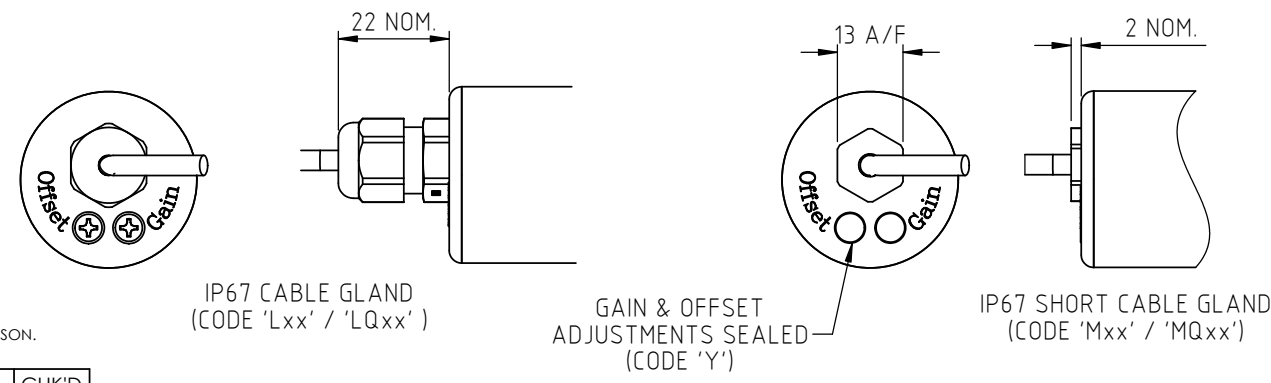
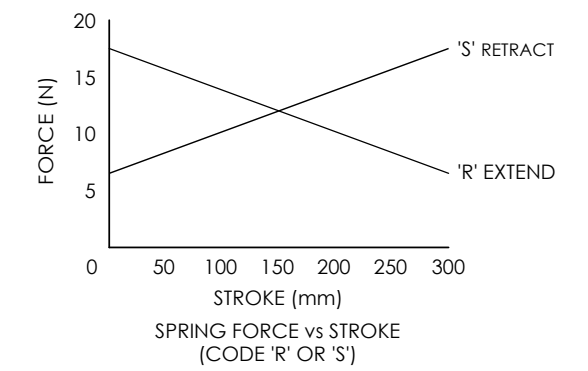
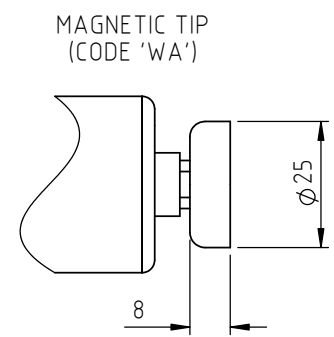
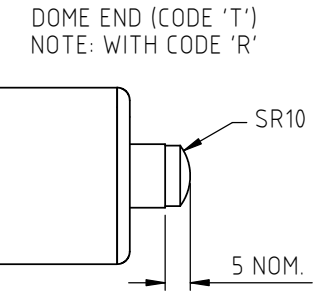
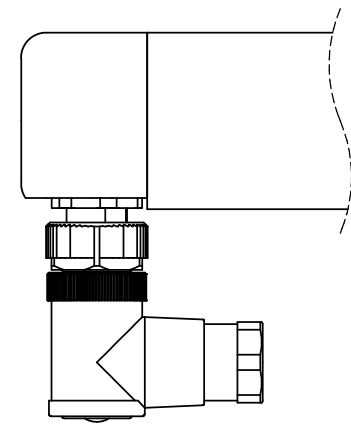

IP67 CABLE GLAND
(CODE 'Lxx' / 'LQxx')

GAIN & OFFSET
ADJUSTMENTS SEALED
(CODE 'Y')

IP67 SHORT CABLE GLAND
(CODE 'Mxx' / 'MQxx')

DRAWINGS NOT TO BE CHANGED WITHOUT REFERENCE TO THE CHANGE PROCEDURE.
CHANGES TO PARTS USED IN INTRINSICALLY SAFE PRODUCT MUST BE APPROVED BY THE AUTHORISED PERSON.
THIS IS AN UNCONTROLLED PRINT AND WILL NOT BE UPDATED.

REV	CHANGE HISTORY	DR'WN	DATE	CHK'D
P	RAN 1311 - MAGNETIC TIP OPTION 'WA' ADDED	ASC	05/06/2023	ASC

THE PUSH-ROD RETRACTS 4mm NOM. BACK FROM THE START OF CALIBRATED TRAVEL.
THE PUSH-ROD EXTENDS 8mm NOM. BEYOND THE END OF CALIBRATED TRAVEL.
SPRUNG OPTIONS:- CODE 'R': 1mm, CODE 'S': 2mm.
CODE 'V': PUSH-ROD NOT RETAINED.



APPROVED BY RDM	REV P	X ±0.4 X.X ±0.2 X.XX ±0.1 DIMS mm
DESCRIPTION P111 RUGGED STAND ALONE LINEAR POSITION SENSOR		
SCALE 2:3	DRAWING NUMBER P111-11	
A3	SHEET 1 OF 1	



P111 RUGGED STAND-ALONE LINEAR POSITION SENSOR

Position feedback for industrial and scientific applications

- **Non-contacting inductive technology to eliminate wear**
- **Travel set to customer's requirement**
- **Compact and self-contained**
- **High durability and reliability**
- **High accuracy and stability**
- **Sealing to IP65/IP67 as required**



As a leading designer and manufacturer of linear, rotary, tilt and intrinsically safe position sensors, Positek® has the expertise to supply a sensor to suit a wide variety of applications.

Our P111 is a heavy-duty version of the P101 sensor with a stronger 12.6mm push rod, recommended for applications where vibration is an issue or there is a need for longer travel sensors, mounted horizontally, and supported between rod eyes. It remains an affordable, durable, high-accuracy position sensor designed for industrial and scientific feedback applications.

The unit is highly compact and space-efficient, being responsive along almost its entire length. Like all Positek® sensors, the P111 provides a linear output proportional to travel. Each sensor is supplied with the output calibrated to the travel required by the customer, any stroke from 0-5mm to 0-800mm and with full EMC protection built in. The sensor is very robust, the body and push rod being made of stainless steel for long service life and environmental resistance. It is particularly suitable for OEMs seeking good sensor performance for arduous applications such as industrial machinery where cost is important.

Overall performance, repeatability and stability are outstanding over a wide temperature range. The sensor is easy to install with mounting options including M8 rod eye bearings and body clamps. The push rod can be supplied free or captive, with female M8 thread, an M8 rod eye, or dome end or magnetic tip. Captive push rods can be sprung loaded, in either direction, on sensors up to 300mm of travel. The P111 also offers a wide range of mechanical and electrical options, environmental sealing is to IP65 or IP67, depending on cable/connector options.

SPECIFICATION

Dimensions

Body diameter	35 mm
Body length (Axial version)	calibrated travel + 163 mm
Body length (Radial version)	calibrated travel + 186 mm
Push rod extension	calibrated travel + 7 mm, OD 12.6 mm

For full mechanical details see drawing P111-11

Independent Linearity

$\leq \pm 0.25\%$ FSO @ 20°C - up to 450 mm

$\leq \pm 0.5\%$ FSO @ 20°C - over 450 mm

Temperature Coefficients

$< \pm 0.01\%/^{\circ}\text{C}$ Gain &

$< \pm 0.01\%$ FS/ $^{\circ}\text{C}$ Offset

Frequency Response

> 10 kHz (-3dB)

> 300 Hz (-3dB) 2 wire 4 to 20 mA

Resolution

Infinite

Noise

$< 0.02\%$ FSO

Environmental Temperature Limits

Operating -40°C to +125°C standard

-20°C to +85°C buffered

-40°C to +125°C

Storage

IP65/IP67 depending on connector / cable option

Sealing

EN 61000-6-2, EN 61000-6-3

EMC Performance

Vibration IEC 68-2-6: 10 g

Shock IEC 68-2-29: 40 g

MTBF

350,000 hrs 40°C Gf

Drawing List

P111-11 Sensor Outline

3D models, step or .igs format, available on request.

Do you need a position sensor made to order to suit a particular installation requirement or specification? We'll be happy to modify any of our designs to suit your needs - please contact us with your requirements.

For further information please contact:

www.positek.com sales@positek.com

Tel: +44(0)1242 820027 fax: +44(0)1242 820615

Positek, Andoversford Industrial Estate, Cheltenham GL54 4LB. U.K.



P111 RUGGED STAND-ALONE LINEAR POSITION SENSOR

Position feedback for industrial and scientific applications

How Positek's technology eliminates wear for longer life

Positek's Inductive technology is a major advance in displacement sensor design. Our displacement transducers have the simplicity of a potentiometer with the life of an LVDT/RVDT. Our technology combines the best in fundamental inductive principles with advanced micro-electronic integrated circuit technology. A Positek sensor, based on simple inductive coils using Positek's ASIC control technology, directly measures absolute position giving a DC analogue output signal. Because there is no contact between moving electrical components, reliability is high and wear is eliminated for an exceptionally long life. It also overcomes the drawbacks of LVDT technology – bulky coils, poor length-to-stroke ratio and the need for special magnetic materials, no requirement for separate signal conditioning. We also offer a range of ATEX-qualified intrinsically-safe sensors.

P111	a	b	c	d	e	f	g	h	j	k
	Displacement	Output	Adjustments	Connections	Option	Option	Option	Option	Option	Z-code

<p>a Displacement</p> <p>Factory set to any length from 0-5 mm to 0-800 mm (e.g. 0-254 mm)</p> <p>b Output</p> <table border="1"> <thead> <tr> <th>Supply V_{dc} (tolerance)</th> <th>Output</th> <th>Code</th> </tr> </thead> <tbody> <tr> <td>+5V (4.5 - 5.5V)</td> <td>0.5 - 4.5V (ratiometric with supply)</td> <td>A</td> </tr> <tr> <td>±15V nom. (±9 - 28V)</td> <td>±5V</td> <td>B</td> </tr> <tr> <td>+24V nom. (13 - 28V)</td> <td>0.5 - 9.5V</td> <td>C</td> </tr> <tr> <td>±15V nom. (±13.5 - 28V)</td> <td>±10V</td> <td>D</td> </tr> <tr> <td>+24V nom. (18 - 28V)</td> <td>4 - 20mA 2 wire</td> <td>E</td> </tr> <tr> <td>+24V nom. (13 - 28V)</td> <td>4 - 20mA 3 wire Sink</td> <td>F</td> </tr> <tr> <td>+24V nom. (9 - 28V)</td> <td>0.5 - 4.5V</td> <td>G</td> </tr> <tr> <td>+24V nom. (13 - 28V)</td> <td>4 - 20mA 3 wire Source</td> <td>H</td> </tr> </tbody> </table> <p>Supply Current: 'A' 10mA nominal, 12mA max. 'B', 'D' & 'G' 12mA nominal, 15mA max. 'E' 26mA max. 'F' & 'H' 32mA nominal, 35mA max.</p> <p>c Calibration Adjustments</p> <table border="1"> <thead> <tr> <th>Adjustment</th> <th>Code</th> </tr> </thead> <tbody> <tr> <td>Accessible default[†]</td> <td>blank</td> </tr> <tr> <td>Sealed</td> <td>Y</td> </tr> </tbody> </table> <p>[†]Axial version only. Radial version sealed by default.</p> <p>d Connections</p> <table border="1"> <thead> <tr> <th>Connection</th> <th>Code</th> </tr> </thead> <tbody> <tr> <td>Cable gland radial IP67 Pg9 metal</td> <td>Ixx</td> </tr> <tr> <td>Connector axial IP65 4 pin (3+earth) DIN 43650 'C'</td> <td>J</td> </tr> <tr> <td>Connector axial IP65 4 pin (3+earth) DIN 43650 'C' pre-wired</td> <td>Jxx</td> </tr> <tr> <td>Connector radial IP67 4 pin M12 IEC 61076-2-101, nylon</td> <td>K</td> </tr> <tr> <td>Connector radial IP67 4 pin M12 IEC 61076-2-101, nylon pre-wired</td> <td>Kxx</td> </tr> <tr> <td>Cable gland axial IP67 M12, nylon</td> <td>Lxx</td> </tr> <tr> <td>Cable gland, short[†] axial IP67, metal</td> <td>Mxx</td> </tr> </tbody> </table> <p>Specify required cable length 'xx' in cm. e.g. L2000 specifies axial cable gland with 20 m of cable, 50 cm supplied as standard. [†]Nb: restricted cable pull strength.</p>	Supply V _{dc} (tolerance)	Output	Code	+5V (4.5 - 5.5V)	0.5 - 4.5V (ratiometric with supply)	A	±15V nom. (±9 - 28V)	±5V	B	+24V nom. (13 - 28V)	0.5 - 9.5V	C	±15V nom. (±13.5 - 28V)	±10V	D	+24V nom. (18 - 28V)	4 - 20mA 2 wire	E	+24V nom. (13 - 28V)	4 - 20mA 3 wire Sink	F	+24V nom. (9 - 28V)	0.5 - 4.5V	G	+24V nom. (13 - 28V)	4 - 20mA 3 wire Source	H	Adjustment	Code	Accessible default [†]	blank	Sealed	Y	Connection	Code	Cable gland radial IP67 Pg9 metal	Ixx	Connector axial IP65 4 pin (3+earth) DIN 43650 'C'	J	Connector axial IP65 4 pin (3+earth) DIN 43650 'C' pre-wired	Jxx	Connector radial IP67 4 pin M12 IEC 61076-2-101, nylon	K	Connector radial IP67 4 pin M12 IEC 61076-2-101, nylon pre-wired	Kxx	Cable gland axial IP67 M12, nylon	Lxx	Cable gland, short [†] axial IP67, metal	Mxx	<p>e Body Fittings</p> <table border="1"> <thead> <tr> <th>Fitting</th> <th>Code</th> </tr> </thead> <tbody> <tr> <td>None default</td> <td>blank</td> </tr> <tr> <td>M8 Rod-eye bearing radial version only</td> <td>N</td> </tr> </tbody> </table> <p>f Body Clamps</p> <table border="1"> <thead> <tr> <th>Clamp</th> <th>Code</th> </tr> </thead> <tbody> <tr> <td>Body Clamps 1 pair</td> <td>P</td> </tr> <tr> <td>Body Clamps 2 pairs</td> <td>P2</td> </tr> </tbody> </table> <p>g Sprung Push Rod</p> <table border="1"> <thead> <tr> <th>Option</th> <th>Code</th> </tr> </thead> <tbody> <tr> <td>Not sprung default</td> <td>blank</td> </tr> <tr> <td>Spring extend</td> <td>R</td> </tr> <tr> <td>Spring retract</td> <td>S</td> </tr> </tbody> </table> <p>300 mm maximum displacement and captive push rod only.</p> <p>h Push Rod Fittings</p> <table border="1"> <thead> <tr> <th>Fitting</th> <th>Code</th> </tr> </thead> <tbody> <tr> <td>Female thread M8x1.25x12 deep default</td> <td>blank</td> </tr> <tr> <td>Dome end with spring extend option 'R'</td> <td>T</td> </tr> <tr> <td>M8 Rod-eye Bearing</td> <td>U</td> </tr> <tr> <td>Magnetic tip</td> <td>WA</td> </tr> </tbody> </table> <p>j Push Rod</p> <table border="1"> <thead> <tr> <th>Option</th> <th>Code</th> </tr> </thead> <tbody> <tr> <td>Captive push rod retained default</td> <td>blank</td> </tr> <tr> <td>Non-captive push rod can depart body</td> <td>V</td> </tr> </tbody> </table> <p>k Z-code (optional)</p> <table border="1"> <thead> <tr> <th>Option</th> <th>Code</th> </tr> </thead> <tbody> <tr> <td>Option 'J' with IP67 M12 IEC 61076-2-101 conn. No access to cal. Adjustments, must include option 'Y'</td> <td>Z600</td> </tr> <tr> <td>Option 'J' with IP67 M12 IEC 61076-2-101 conn. with access to cal. adjustments</td> <td>Z601</td> </tr> <tr> <td>Tighter Independent Linearity; ≤± xx% FSO @20°C</td> <td>Z650</td> </tr> <tr> <td>≤± 0.1% 0 - 10 mm min. to 0 - 450 mm</td> <td></td> </tr> <tr> <td>≤± 0.25% 0 - 451 mm to 0 - 600 mm</td> <td></td> </tr> <tr> <td>≤± 0.5% 0 - 601 mm to 0- 800 mm max.</td> <td></td> </tr> <tr> <td>1/2" Rod eyes with options 'N' and/or 'U'</td> <td>Z825</td> </tr> <tr> <td>M12Rod eyes with options 'N' and/or 'U'</td> <td>Z826</td> </tr> </tbody> </table>	Fitting	Code	None default	blank	M8 Rod-eye bearing radial version only	N	Clamp	Code	Body Clamps 1 pair	P	Body Clamps 2 pairs	P2	Option	Code	Not sprung default	blank	Spring extend	R	Spring retract	S	Fitting	Code	Female thread M8x1.25x12 deep default	blank	Dome end with spring extend option 'R'	T	M8 Rod-eye Bearing	U	Magnetic tip	WA	Option	Code	Captive push rod retained default	blank	Non-captive push rod can depart body	V	Option	Code	Option 'J' with IP67 M12 IEC 61076-2-101 conn. No access to cal. Adjustments, must include option 'Y'	Z600	Option 'J' with IP67 M12 IEC 61076-2-101 conn. with access to cal. adjustments	Z601	Tighter Independent Linearity; ≤± xx% FSO @20°C	Z650	≤± 0.1% 0 - 10 mm min. to 0 - 450 mm		≤± 0.25% 0 - 451 mm to 0 - 600 mm		≤± 0.5% 0 - 601 mm to 0- 800 mm max.		1/2" Rod eyes with options 'N' and/or 'U'	Z825	M12Rod eyes with options 'N' and/or 'U'	Z826
Supply V _{dc} (tolerance)	Output	Code																																																																																																						
+5V (4.5 - 5.5V)	0.5 - 4.5V (ratiometric with supply)	A																																																																																																						
±15V nom. (±9 - 28V)	±5V	B																																																																																																						
+24V nom. (13 - 28V)	0.5 - 9.5V	C																																																																																																						
±15V nom. (±13.5 - 28V)	±10V	D																																																																																																						
+24V nom. (18 - 28V)	4 - 20mA 2 wire	E																																																																																																						
+24V nom. (13 - 28V)	4 - 20mA 3 wire Sink	F																																																																																																						
+24V nom. (9 - 28V)	0.5 - 4.5V	G																																																																																																						
+24V nom. (13 - 28V)	4 - 20mA 3 wire Source	H																																																																																																						
Adjustment	Code																																																																																																							
Accessible default [†]	blank																																																																																																							
Sealed	Y																																																																																																							
Connection	Code																																																																																																							
Cable gland radial IP67 Pg9 metal	Ixx																																																																																																							
Connector axial IP65 4 pin (3+earth) DIN 43650 'C'	J																																																																																																							
Connector axial IP65 4 pin (3+earth) DIN 43650 'C' pre-wired	Jxx																																																																																																							
Connector radial IP67 4 pin M12 IEC 61076-2-101, nylon	K																																																																																																							
Connector radial IP67 4 pin M12 IEC 61076-2-101, nylon pre-wired	Kxx																																																																																																							
Cable gland axial IP67 M12, nylon	Lxx																																																																																																							
Cable gland, short [†] axial IP67, metal	Mxx																																																																																																							
Fitting	Code																																																																																																							
None default	blank																																																																																																							
M8 Rod-eye bearing radial version only	N																																																																																																							
Clamp	Code																																																																																																							
Body Clamps 1 pair	P																																																																																																							
Body Clamps 2 pairs	P2																																																																																																							
Option	Code																																																																																																							
Not sprung default	blank																																																																																																							
Spring extend	R																																																																																																							
Spring retract	S																																																																																																							
Fitting	Code																																																																																																							
Female thread M8x1.25x12 deep default	blank																																																																																																							
Dome end with spring extend option 'R'	T																																																																																																							
M8 Rod-eye Bearing	U																																																																																																							
Magnetic tip	WA																																																																																																							
Option	Code																																																																																																							
Captive push rod retained default	blank																																																																																																							
Non-captive push rod can depart body	V																																																																																																							
Option	Code																																																																																																							
Option 'J' with IP67 M12 IEC 61076-2-101 conn. No access to cal. Adjustments, must include option 'Y'	Z600																																																																																																							
Option 'J' with IP67 M12 IEC 61076-2-101 conn. with access to cal. adjustments	Z601																																																																																																							
Tighter Independent Linearity; ≤± xx% FSO @20°C	Z650																																																																																																							
≤± 0.1% 0 - 10 mm min. to 0 - 450 mm																																																																																																								
≤± 0.25% 0 - 451 mm to 0 - 600 mm																																																																																																								
≤± 0.5% 0 - 601 mm to 0- 800 mm max.																																																																																																								
1/2" Rod eyes with options 'N' and/or 'U'	Z825																																																																																																							
M12Rod eyes with options 'N' and/or 'U'	Z826																																																																																																							

Output Characteristic - Standard

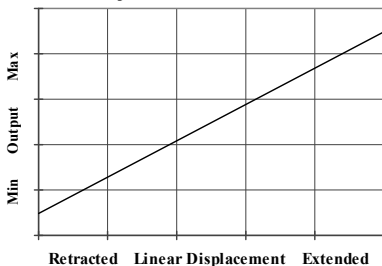

Output Characteristic - Reverse option

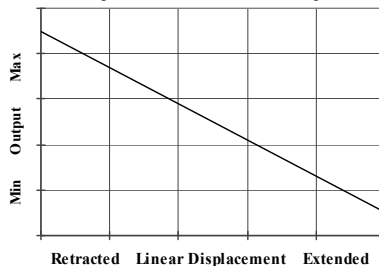

For further information please contact:

www.positek.com sales@positek.com

Tel: +44(0)1242 820027 fax: +44(0)1242 820615

Positek, Andoversford Industrial Estate, Cheltenham GL54 4LB. U.K.

Installation Information

P111 RUGGED STAND-ALONE LINEAR POSITION SENSOR

Output Option	Output Description:	Supply Voltage: V_s (tolerance)	Load resistance: (include leads for 4 to 20mA O/Ps)
A	0.5 - 4.5V (ratiometric with supply)	+5V (4.5 - 5.5V)	$\geq 5k\Omega$
B	$\pm 5V$	$\pm 15V$ nom. ($\pm 9 - 28V$)	$\geq 5k\Omega$
C	0.5 - 9.5V	+24V nom. (13 - 28V)	$\geq 5k\Omega$
D	$\pm 10V$	$\pm 15V$ nom. ($\pm 13.5 - 28V$)	$\geq 5k\Omega$
E	4 - 20mA 2 wire Current Loop	+24V nom. (18 - 28V)	$\approx 0 - 300\Omega$ max. @24V ~ 1.2 to 6V across 300 Ω $\{R_L \text{ max.} = (V_s - 18) / 20^{-3}\}$
F	4 - 20mA 3 wire Sink	+24V nom. (13 - 28V)	$\approx 0 - 950\Omega$ max. @24V ~ 3.8 to 19V across 950 Ω $\{R_L \text{ max.} = (V_s - 5) / 20^{-3}\}$
G	0.5 - 4.5V	+24V nom. (9 - 28V)	$\geq 5k\Omega$
H	4 - 20mA 3 wire Source	+24V nom. (13 - 28V)	$\approx 0 - 300\Omega$ max. ~ 1.2 to 6V across 300 Ω

Not all output options available - see product datasheet for full options list

Connector Pinout
(Front View)

DIN 43650 C

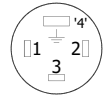

M12 IEC

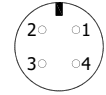

'A', 'C', 'G' & 'H'

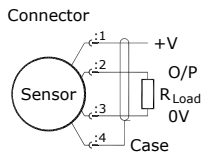
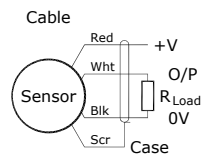

'B' & 'D'

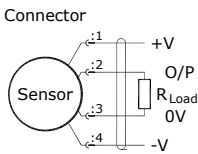
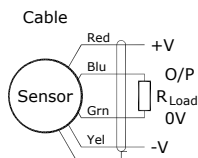

'E'

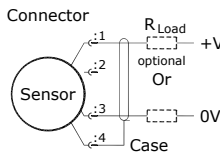
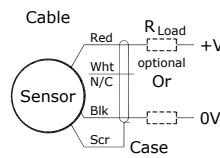

'F'

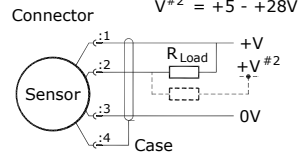
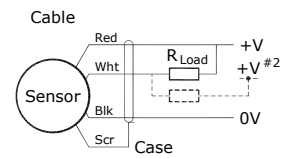

Gain and Offset Adjustment: (Where accessible - Typically $\pm 10\%$ Min available)

To adjust the gain or offset use a small potentiometer adjuster or screwdriver 2mm across. Do not apply too much force on the potentiometers.

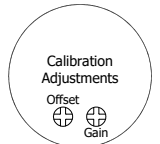

Mechanical Mounting: Depending on options; Body can be mounted by rod eye or by clamping the sensor body - body clamps are available, if not already ordered. Target by M8x1.25 female thread, rod eye or magnetic tip. It is assumed that the sensor and target mounting points share a common earth.

Output Characteristic: Target is extended 7 mm from end of body at start of normal travel. The output increases as the target extends from the sensor body, the calibrated stroke is between 5 mm and 800 mm.

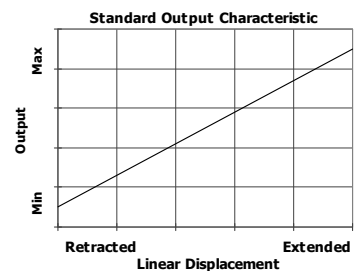

Warning - The M12 IEC connector may be rotated for purposes of convenient orientation of the connector and cable, however rotating the connector more than one complete revolution is not recommended. **Repeated rotation of the connector will damage the internal wiring!**

Incorrect Connection Protection levels:-

- A **Not protected** – the sensor is **not** protected against either reverse polarity or over-voltage. The risk of damage should be minimal where the supply current is limited to less than 50mA.
- B & D Supply leads diode protected. Output must not be taken outside $\pm 12V$.
- C & G Supply leads diode protected. Output must not be taken outside 0 to 12V.
- E, F & H Protected against any misconnection within the rated voltage.

For further information please contact:

www.positek.com sales@positek.com

Tel: +44(0)1242 820027 fax: +44(0)1242 820615

Positek Ltd, Andoversford Industrial Estate, Cheltenham GL54 4LB. U.K.